



Federal Democratic Republic of  
Ethiopia  
Ministry of Health

**BIOMEDICAL  
EDUCATION TRAINING  
ON MCH MEDICAL  
EQUIPMENT**

---



# Biomedical training on MCH medical equipment Participant manual

April, 2019  
Addis Ababa



# Table of Contents

Forward	II
Acknowledgment	III
List of acronyms and abbreviations	List
of Figures	VIII
Introduction to the manual	IX
Course syllabus for MCH equipment	X
Course description	I
<b>CHAPTER 1: Caring, Respectful and Companionate Healthcare Service</b>	<b>1</b>
1.1. Introduction to Compassionate, Respectful and Caring (CRC)	2
1.1.1. Definition of CRC	2
1.1.2. Why CRC a Transformation Agenda	2
1.1.3. The Benefits of CRC	3
1.1.4. National Strategy and Approach of CRC	4
1.2. Healthcare Ethics	4
1.2.1. Principles of Health Care Ethics	4
1.2.2. Confidentiality and Informed Consent	6
1.2.3. Preventive Ethics in the Aspect of CRC	7
1.2.4. Ethics and Law as Enablers of CRC	7
1.3. Principles and Standards of Compassionate Care	9
1.3.1. Qualities of compassionate care	9
1.3.2. Elements of compassionate care	
1.3.3. Principles of compassionate care	
1.3.4. Threats to compassionate care	12
1.4. Respectful care	13
1.4.1. Definition of Concepts of Respectful and Dignified Care	13
1.4.2. Principles of Respectful Care	15
1.4.3. Characteristics of Disrespectful Care	15
1.4.4. Factors affecting Respectful Care Provision	16
1.5. Compassionate leader	18
1.5.1. Quality of Compassionate Leadership	18
1.5.2. System Thinking for CRC	20
1.5.3. Organizational Culture	21
1.5.4. Leading CRC Health Teams	22

<b>CHAPTER 2: Infant incubator</b>	<b>25</b>
2.1. Introduction	26
2.1.1 Purpose / clinical application	
2.2 . Working principle	
2.3. Basic parts and function	27
2.3.1 The major components of an infant incubator system are	27
2.3. 2. Function of Incubator components	28
2.4. Classification	28
2.5. Safety and care of the device	29
2.6. Troubleshooting techniques	29
2.6.1. Preparatory steps of troubleshooting technique	29
2.6.2. Troubleshooting procedures to detect major component failures	30
2.7. Maintenance and Repair procedure	
2.8. Preventive Maintenances	32
2.9. Performance test for Infant Incubator	33
2.10. summary	33
<b>CHAPTER 3: Infant radiant warmer</b>	<b>3.1.</b>
Introduction	35
3.2. Purpose / clinical application	35
3.3 Working principle	35
3.4 Basic parts and function	36
3.5. Infant radiant warmer components function	36
3.6. Classification	37
3.7 Safety and care of the device	37
3.8. Troubleshooting techniques	38
3.8.1. Preparatory Steps of Troubleshooting Technique	38
3.8.2. Troubleshooting Procedures to Detect Major Component Failures	39
3.9. Maintenance and Repair	39
3.9.1. Preventive maintenance procedure	40
3.10. Performance test for Infant Radiant Warmer	41
3.11. Summary	41
<b>CHAPTER 4:</b>	
<b>Fetal monitor</b>	<b>42</b>
4.1.Purpose/clinical application	43
4.2. Working principle	43
4.3. Basic parts and function	44
4.3.1. Basic Parts	44
4.3.2. Basic Parts Function	44

4.4. Safety and care of the device	45
4.5. Troubleshooting Techniques	45
4.5.1. Receives Maintenance Request	45
4.5.2. Troubleshooting Procedures	46
4.6 Maintenance and Repair	46
4.7. Preventive maintenance procedure	47
4.8 Performance Test for Fetal Monitor	47
4.9. Summary	4
<b>CHAPTER 5: CPAP Machine</b>	
5.1. Purpose / clinical application	50
5.2 Working principle	50
5.3 Basic parts and function	51
5.3.1 Basic parts	51
5.3.2 Parts function	51
5.3.3. Classification	52
5.3.4. Safety and care of the device	52
5.4. Troubleshooting Procedure	53
5.4.1. Receive maintenance request	53
5.4.2 Physical Inspection	
5.4.3. Power supply check up	
5. 4.4. System verification	
5.4.5 Volume control and transducer checking	54
5.4.6. Maintenance and Repair	54
5. 5. Preventive maintenance procedure	55
5.5.1. Performance Test for CPAP Machine	
5.6. Summary	

Annex 1. Learning guide for MCH Medical devices

Annex 2. Trainee Performance Evaluation Check list for Infant Incubator

Annex 3. Trainee Evaluation Check List for Infant Radiant Warmer

Annex 4. Trainee Evaluation Check list for fetal Monitor

Annex 5. Trainee Evaluation Check list for CPAP Machine

References

# Forward

---

Modern health care services are very much dependent on the use of proper medical devices for diagnosis and treatment. The majority of these devices and equipment are manufactured in developed countries and needs skilled man power to manage and use them lifelong. Because they are applied on human being they need rigorous care and handling for the sake of patient safety and utilize them effectively and efficiently. Even with normal and careful use, they are subject to malfunction.

It is important to take good care of them and employ timely preventive maintenance to keep them working last long and decrease downtime. The proper handling and maintenance of these devices can be achieved by deploying the well trained and competent biomedical Equipment Engineers/ Technicians to the respective health facilities. In line with this, it is also important to provide continuous on job training to build their capacity and introduce them to a new technology. Therefore, this training package is developed to provide TOT for biomedical education training provider institute instructors as well as professional who are working at health facilities to fill their Knowledge, attitude and skill gaps on some selected MCH medical devices.

Regassa Bayissa

Pharmaceutical and medical equipment directorate director

## Approval statement of the ministry

The Federal Ministry of health of Ethiopia has been working towards standardization and institutionalization of In-Service Trainings (IST) at national level. As part of this initiative the ministry developed a national in-service training directive and implementation guide for the health sector. The directive requires all in-service training materials fulfill the standards set in the implementation Guide to ensure the quality of in-service training materials. Accordingly, the ministry reviews and approves existing training materials based on the IST standardization checklist annexed on the IST implementation guide.

As part of the national IST quality control process, this biomedical training on MCH medical equipment package has been reviewed based on the standardization checklist and approved by the ministry in April, 2019.

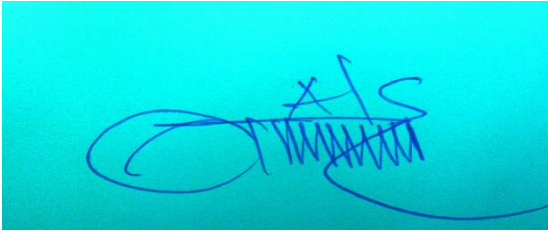
A handwritten signature in blue ink on a white background. The signature is stylized and appears to be 'Assegid Samuel Cheru'. There are some horizontal lines drawn through the middle of the signature.

*Assegid Samuel Cheru  
Human Resource Development Directorate  
A/Director  
Federal Ministry of Health, Ethiopia*

# Acknowledgment

---

The Federal Ministry of Health acknowledges the commitment and technical support of the MCH Medical devices participant manual development team members (listed below) along with their organizations and key contributors who made the development of this Training manual are:

- BihanechWorku, Bsc, (RasDesta Hospital)
- Demoz Kebede, BSc, (FMHACA)
- DemeruYeshitla, MA, (Jhipeg/FMHACA)
- Ermias Haymmanot, BSc, (Zewditu Memorial Hospital)
- Getaneh Girma, (Jhpiego)
- Helen Tiruneh, (Jhpiego)
- Samuel Mengistu, Dr, (Jhpiego)

The write up of this material has been done by three individuals listed above (consultant) with guidance from jhpiego Ethiopia S-HRH Project Education and training Advisors team.

The Ministry would like to thank and acknowledge S-HRH Project funded by technical assistance in the preparation of this Participant manual.



# List of acronyms and abbreviations

---

- MCH** Maternal and Child Health
- CPAP** Continuous Positive Airway Pressure
- LCD** Liquid Crystal Display
- PPE** Personal protective equipment
- CPU** Central Processing Unit
- FHR** Fetal Heart Rate
- RF** Radio Frequency
- JU IT** Jimma University Institute of Technology
- AAU IT** Addis Ababa University Institute of Technology
- AAT PC** Addis Ababa Tegbareid Polytechnique College
- HBC** Human Bridge College
- KPTC** Kombolcha Polytechnique College
- HTM** Health Technology Management
- HRDD** Human Resource Development Directorate

# List of Figures

---

- Figure 1. Infant incubator
- Figure 2. Block diagram of Infant Incubator
- Figure 3. Infant radiant warmer
- Figure 4. Block diagram of Infant radiant warmer
- Figure 5. Block diagram of fetal monitor
- Figure 6. Block diagram for CPAP system
- Figure 7. CPAP Machine components

# Introduction to the Manual

The Federal Ministry of Health's Growth and Transformation Plan (GTP) indicates that by 2018, 16 specialized governmental hospitals, 80 general hospitals, 800 primary hospitals, and 3,200 health centers will be established. Additionally, there are more than 200 private hospitals and diagnostic centers operating in the country. The FMOH reports that these healthcare facilities will need 4,000 newly trained biomedical equipment technicians and 600 biomedical engineers. Ensuring that existing technicians and engineers are equipped with adequate skills is also a challenge. Ethiopia lacks systems to manage the lifecycle of emerging healthcare technologies and medical devices, but has developed a plan to address this.

The current biomedical engineering programs at JU, IT, and AAUIT, and the vocational biomedical technician program at AATPC, HBC, KPC and other newly merging regional TVET Colleges are tasked with producing technicians and engineers to meet the very high demands for trained professionals throughout Ethiopia. Program gaps include a lack of adequate hands-on, practical training opportunities and laboratory/ industrial skills for students, and an acute shortage of academically/industrially/vocationally trained faculty and staff. The existing faculty and staff lack access to modern biomedical training equipment, modern training methodologies, as well as evidence-based information on biomedical devices that is in line with international standards and best practices. This deprives students/trainees of standardized protocols and training in devices maintenance and management and leads to an unstructured career path for students.

The HRH Project through its close working relation with those institutes has made discussions with teaching staff's and biomedical departments to gather the information regarding the training demand and discussed with the FMOH, HRD directorate and decided to develop these standard training packages for the purpose of conducting technical update training on some selected medical devices. The HRH project, Core biomedical Engineers coordinate this training package development activity in collaboration with FMOH technical experts, we hope this will be a good opportunities for faculty, staff, and HTM personnel's to fill the skill gap on the selected medical devices and as a result improves the faculty teaching learning process.

## **THE FOLLOWING ARE THE CORE COMPETENCE OF THIS TRAINING MANUAL.**

- Explain operation principles of some selected MCH medical devices
- Identify the basic components of the selected operation MCH equipments
- Practice the proper handling and safe use of MCH medical devices
- Apply appropriate troubleshooting procedures for each equipment.
- Perform preventive and corrective maintenance as per the manufacturer manual
- Perform performance test and calibration as demanded





# Course syllabus

## COURSE DESCRIPTION

This a 4 days, MCH medical equipment's training course is designed to equip biomedical engineers/ technicians to maintain MCH medical equipment's (infant incubators, infant radiant warmer, CPAP and fetal monitor)

## COURSE GOAL:

To provide the participants with knowledge, skill and attitude needed for maintenance of MCH medical equipment.

## COURSE OBJECTIVES:

At the end of this course Participant will be able to:-

- Describe purpose of MCH medical equipment
- Explain working principle of MCH medical equipment
- Differentiate basic parts and function of MCH medical equipment
- Perform troubleshooting of MCH medical equipment
- Perform calibration of MCH medical equipment
- Practice safe handling of MCH devices
- Perform preventive ,curative maintenance and performance test of MCH medical equipment
- Maintain preventive and curative MCH medical equipment
- Test the performance of preventive and curative MCH medical equipment

## TRAINING METHOD

- Brainstorming
- Interactive presentation
- Group based exercise ( Case scenario,, group discussion ...)
- Demonstration and coaching
- Simulation and observation
- Troubleshooting exercise

## TRAINING MATERIAL AND INSTRUMENT

- Trainees manual
- Facilitator's guide
- Reference manuals
- Training video tape
- Infant incubators, infant radiant warmer, CPAP, and fetal monitor
- Hand tools, measuring and testing tools
- Stationary materials
- PPT

## **PARTICIPANT SELECTION:**

Participant for this course should be biomedical engineers/technicians and registered professional working on medical device maintenance

## **METHODS OF EVALUATION**

- Participant o
  - Formative
    - Pre-test
    - Group exercises/ demonstration using checklists
  - o Summative
    - Knowledge assessment (30 %):
    - Practical assessment (70%):

## **COURSE EVALUATION**

- o Daily Evaluation
- o Daily trainers feedback meeting
- o End of Course Evaluation

## **TRAINERS' SELECTION CRITERIA**

- The facilitators of this course will be consultants (TWG) who have developed the course or who has a minimum of BSc Degree in Biomedical Engineering and has the relevant practical experience on MCH devices preferably at Health facility,
- TOT on MCH Equipment,
- Basic training on MCH Equipment with Training Facilitation skill.

## **COURSE VENUE**

- Accredited in-service training centers with functional internet service and With convenient facilities (equipment for practice preferably hospitals)

## **COURSE DURATION**

- 4days

## **COURSE COMPOSITION (30/70)**

- 20 – 25 participants at a time
- 4 trainers

# Course Schedule

Day 1	Time	Activity	Duration	Facilitator	Moderator	
Morning	8:30 – 9:30AM	Registration	1 hr.			
	9:30- 9:45 AM	Welcoming /Opening remark	15 minutes			
	9:45 – 9:55 Am	Participants self-introduce and expectation	10 minutes	All participants	All facilitators	
	9:55 - 10:30AM	Pretest	35 minutes			
	10:30- 10:45		Coffee Break			
		Chapter 1: CRC	160 min			
	10:45- 12:30 PM	Introduction to CRC	30 mns			
12:30- 1:30		Lunch				
Afternoon	1:30- 8:00Pm	Health Ethics	30mns			
	8:00-8:40	Compassionate care	40 mns			
	8:40-9:10	Respectfull care	30 mns			
	9:10-9:35	Compassionate care	25			
	9:35-10:5	Respectfull care	30			
	10:5-10:20		Coffe Break	10 mns		
	10:20-10:45	Compassionate leader	25mns			
	10:45-11:00	Summary	5mns			
	5:20- 5:30PM		10 Minutes	All facilitators		
Day 2	Time	Activity	Duration	Facilitator	Moderator	
Morning	8:30 – 8:45	Recap	30 minutes	All the participants	Facilitators	
		Chapter 2: Infant Incubator	385 mns			
	8:45 - 10:15	Introduction to Infant Incubator	30mns			
	10:00- 10:15am		Coffee Break			
	10:15- 10:25 PM	Purpose/clinical application	10 mns			
	10:25-4:40	Working principle	15 mns			
	4:40-5:10	Basic parts	30 mns			
	5:10-5:15	Classification	5 mns			
	5:15-5:25	Safety and care of device	10 mns			
	5:25 6:30	Preventive maintenance	55 mns			
12:30- 1:30		Lunch				
Afternoon	1:30- 5:00 PM	Trouble shooting & repair procedures	3:30 hrs			
	5:00-5:30 pm	Summary	30 mns			

Day 3	Time	Activity	Duration			
<b>Morning</b>	8:30 - 9:00	Recap	30 minutes	Participant		
		Chapter 3:Infant Radiant Warmer	370 mns(7 hrs)			
	9:00 - 9:20	Introduction	20 min			
	9:20-9:30	Purpose/clinical application	10 mns			
	9:30-9:40	Working principles	10 mns			
	9:40-4:00	Basic Parts	20 mns			
	10:00- 10:15		<b>Coffee Break</b>			
	10:00- 10:35	Type/classification	35 min			
	10:35-10:45	Safety and care of device	15 mns			
	10:45-12:00	Preventive maintenances	2:25 mns			
12:30- 1:30		<b>Lunch</b>				
<b>Afternoon</b>	1:30- 3:30	Troubleshooting techniques	2:10 mns			
	4:30- 4:45		<b>Coffee Break</b>			
	4:45- 5:15	Performance test for Infant Radiant Warmer	30 mns			
	5:15-5:40	Summary	30 mns			
<b>Day 4</b>	<b>Time</b>	<b>Activity</b>	<b>Duration</b>			
<b>Morning</b>	8:30 - 9:00	Recap	30 minutes			
		Chapter 4:Fetal Monitor				
	9:00 – 9:15	Introduction	15 mns			
	9:15- 9:25 am	Purpose/clinical application	10 mns			
	9:25-9:35	Working principles	10 mns			
	9:35-4:05	Basic parts	30 mns			
	4:05-4:20		<b>Coffee Break</b>		15 mns	
	4:20- 12:30	Preventive maintenances	80 mns			
12:30-1:30		<b>Lunch</b>				
<b>Afternoon</b>	1:30-3:30	Troubleshooting and repair	2:20			
	3:30-4:00	Summary	30 mns			
<b>Day 5</b>	<b>Time</b>	<b>Activity</b>	<b>Duration</b>			
<b>Morning</b>	8:30 - 9:00	Recap	30 mns			
		Chapter 5:CPAP Machine				
	9:00 - 9:15	Introduction	15mns			
	9:15-9:20	Purpose/clinical application	5 mns			
	9:20-10:00	Working principle	45 mns			
	10:00- 10:15		<b>Coffee Break</b>			
	10:15- 5:30	Basic parts	45 mns			
	5:30-12:00	Classification	30 mns			



	12:00-12:15	Safety and care of the device	15 mns			
12:30- 1:30 <b>Lunch</b>						
<b>Afternoon</b>	1:30- 2:15	Preventive maintenances	45 mns			
	2:15-4:30	Troubleshooting techniques and Repair	2:15			
	4:30- 4:45 <b>Coffee Break</b>					
	4:45- 5:20	Summary	35 minutes			
	5:20- 5:30	Closing and Final speech	30 mns			

# Chapter 1:

## Caring, Respectful and Companionate Healthcare Service

### CHAPTER DESCRIPTION:

This chapter is designed to equip healthcare professionals and senior management in health facilities to increase core competencies of compassionate, respectful, holistic, scientifically and culturally acceptable care for patients and their families.

### CHAPTER OBJECTIVE:

By the end of this chapter the participants will be able to:

- Describe Compassionate, respectful and Caring (CRC) healthcare service delivery

### ENABLING OBJECTIVES:

By the end of this chapter participants will be able to:

- Describe Compassionate, respectful and caring (CRC)
- List principles of health care Ethics
- Discuss components of compassionate care
- Explain principles of respectful care
- Discuss characteristics of Compassionate leader

### CHAPTER OUTLINE

- 1.1. Introduction to CRC
- 1.2. Healthcare Ethics
- 1.3. Compassionate care
- 1.4. Respectful care
- 1.5. Compassionate leader
- 1.6 Summery

## 1.1. INTRODUCTION TO COMPASSIONATE, RESPECTFUL AND CARING (CRC)

	<p><b>Individual reflection</b></p> <p><b>What is Compassionate, Respect and Caring (CRC)?</b></p> <p><b>Time Allowed 15 minutes</b></p>
---	--

### 1.1.1. DEFINITION OF CRC

#### Compassion (ፋህፋህ)

Is a feeling of deep sympathy and sorrow for the suffering of others accompanied by a strong desire to alleviate the suffering? Therefore, we can say it is being sensitive to the pain or suffering of others and a deep desire to alleviate the suffering.

#### Respectful (ተገልጋይንዮሚያክብር)



Is the kind of care, in any setting, which supports and promotes, and does not undermine a person's self-respect, regardless of any differences?

#### Caring (ተንከባካቢ)

**Caring** is an intensification of the affective dimension of empathy in the context of significant Suffering. It is coupled with effective interventions to alleviate that suffering.

#### Compassionate, respectful and Caring (CRC) -

Means serving patients, being ethical, living the professional oath, and being a model for young professionals and students. It's a movement that requires champions who identify with their profession and take pride by helping people.

 Think	<p><b>•Why CRC a transformational agenda?</b></p> <p><b>Time Allowed 10 minutes</b></p>
 Pair	
 Share	

### 1.1.2. WHY CRC A TRANSFORMATION AGENDA?

Helping health professionals' to become compassionate and respectful practitioners remains a major challenge for the healthcare. Compassionate and respectful care is not only morally and financially essential, but it is required in many countries through national legislation and/or national health policy. The notion that healthcare services must be expanded beyond the prevention of morbidity or mortality is only one aspect of the agenda. It must encompass respect for patients' basic human rights, including respect for patients' autonomy, dignity, feelings, choices, and preferences. It must include choice of companionship wherever possible.

Taken from the United Nations human rights declaration, 'All human beings are born free and equal in dignity and rights.' The Ethiopian constitution of human rights article 25 and 26 states that the rights to equality and privacy.

In the Ethiopian health system, there are many health professionals who have dedicated their entire career to public service and are respected by the public they serve. However, a significant proportion of health professionals see patients as just 'cases' and do not show compassion. Lack of respect to patients and their families is also a common complaint.

A three-year report of the Ethics Committee and relevant documents in Addis Ababa showed that 39 complaints were related to death of the patient and 15 complaints were about disability. The committee verified that 14 of the 60 claims had an ethical breach and/or negligence and other study also indicated that forwarding bad words, shouting on patients, mistreatment, insulting and hitting of clients are some of unethical practices showed by the health professionals.

### STUDIES SHOWED THE NEED FOR CRC

- Lack of role models in many health facilities.
- Measuring the worth of a profession by how much it pays.
- Senior physicians cancel their outpatient clinics without informing their patients.
- Elective surgeries get cancelled.
- Admitted patients are by default getting the care they need from relatives.
- Nurses, for various reasons, have limited their role to providing injections and securing IV lines.
- Proper counseling during dispensing of drugs is also becoming a rarity.
- The quality of lab tests and the quality assurance process that lab professionals have to take before issuing results is not practiced as expected.
- Lack of compassion, respect and care is the common source of grievances in health facilities.

#### 1.1.3. THE BENEFITS OF CRC

**Table 1. The benefits and beneficiaries of Compassionate and Respectful Care**

Beneficiaries	Who	How
First	Patients	<ul style="list-style-type: none"> <li>• When health professionals are compassionate, patients are less anxious</li> <li>• Adherence to medical advice and treatment plans</li> <li>• Compassionate care correlates positively with both prevention and disease management. Diabetic patients, for example, demonstrate higher self-management skills when they self-report positive relationships with their providers</li> <li>• Hostile emotional states in patients delay the healing processes</li> <li>• Quality of health professionals –patient communication with increased physical functioning, emotional health and decreased physical symptoms of pain in patients</li> </ul>
Second	Health Professionals	<ul style="list-style-type: none"> <li>• Health care Professionals satisfaction with their relationships with patients can protect against professional stress, burnout, substance abuse and even suicide attempts</li> <li>• Burnout is strongly associated with poorer quality of care, patient dissatisfaction, increased medical errors, lawsuits and decreased expressions of compassion</li> <li>• Participation in a mindful communication associated with short-term and sustained improvement in well-being and attitudes associated with patient care</li> <li>• A major predictor of patient loyalty</li> <li>• When health professionals are compassionate, they achieve earlier and more accurate diagnoses because the patient is better able to reveal information when he or she feels emotionally relaxed and safe</li> <li>• Respect from the client/patients</li> <li>• Health professionals will find their work more meaningful and gratifying</li> </ul>
Third	Students	<ul style="list-style-type: none"> <li>• Good role modeling is essential for students</li> <li>• Increased motivation to be CRC health professionals</li> </ul>
Fourth	Health care facilities	<ul style="list-style-type: none"> <li>• Patient satisfaction will rise</li> <li>• Quality of health care will be improved</li> <li>• Lower malpractice suits</li> <li>• Staff will be more loyal to their hospital or health care system</li> <li>• Patient adherence to treatment will rise</li> <li>• Resources can be conserved</li> <li>• Greater employee satisfaction and reduced employee turnover.</li> </ul>

### 1.1.4. NATIONAL STRATEGY AND APPROACH OF CRC

The development of caring, respectful and compassionate health workers requires a multi-pronged approach in order to make CRC as a culture, self-driven inner motive and a legacy that the current generation of practitioners leaves to their successors.

#### NATIONAL STRATEGY AND APPROACHES FOR CRC

- Reforming the recruitment of students for health science and medicine programs.
- Improving the curriculum of the various disciplines.
- Ownership and engagement of the leadership at all levels of the system.
- Inspirational leadership that aims to create an enabling environment.
- National, regional and facility level ambassadors.
- An advocacy campaign through mass media will also be launched to project positive images of health professionals.
- Patients and the general public will also be engaged in this movement.
- An annual health professional recognition event will be organized
- Putting in place a favorable legislative framework to reinforce CRC which would include regulation on patients' rights and responsibilities (PRR)
- Measurement of health care providers on CRC
- Comprehensive projects will be designed.
- Conducting national assessment related to CRC.
- Provision of continuous CRC trainings.
- Engagement and ownership of professional associations.
- Experience sharing from national and international best practices.



## 1.2. HEALTHCARE ETHICS

### 1.2.1. PRINCIPLES OF HEALTH CARE ETHICS



#### Individual reflection

- ❖ What is ethics?
- ❖ What is health care ethics?

Time: 5 Minutes

#### Ethics:

Ethics is derived from the Greek word ethos, meaning custom or character. Ethics is the study of morality, which carefully and systematically analyze and reflect moral decisions and behaviors, whether past, present or future. It is a branch of philosophy dealing with standards of conduct and moral judgment. Health care ethics:

It is a set of moral principles, beliefs and values that guide us to make choices about healthcare. The field of health and healthcare raises numerous ethical concerns, including issues of health care delivery, professional integrity, data handling, use of human subjects in research and the application of new techniques.

Ethical principles are the foundations of ethical analysis because they are the viewpoints that guide a decision. There are four fundamental principles of healthcare ethics.

1. Autonomy
2. Beneficence
3. Non-maleficence
4. Justice

## 1. AUTONOMY

Autonomy is the promotion of independent choice, self-determination and freedom of action. Autonomy implies independence and ability to be self-directed in one's healthcare. It is the basis of self-determination and entitles the patient to make decisions about what will happen to his or her body.



### Case one:

A 49-year-old client with diabetic finding came with right foot second finger gangrene to a hospital. The surgeon decided that the finger should be removed immediately. But the patient refused the procedure.

**Question:** How should the surgeon handle this case?

**Time: 5 Minutes**

## 2. BENEFICENCE

Beneficence is the ethical principle which morally obliges health workers to do positive and rightful things. It is “doing what is best to the patient”. In the context of professional-patient relationship the professionals are obliged to always and without exception, favor the wellbeing and interest of their patients.



### Case two:

Ms. X was admitted to adult surgical ward with severe excruciating right flank pain with presumptive diagnosis of renal colic. Nurse Y was the duty nurse working that day. The physician who saw her at OPD did not write any order to alleviate the pain.

**Question:** What should the attending nurse do for Ms. X?

**Time: 5 Minutes**

## 3. NON-MALEFICENCE

The principle refers to “avoid doing harm”. Patient can be harmed through omitting or committing interventions. When working with clients, healthcare workers must not cause injury or distress to clients. This principle of non-maleficence encourages the avoidance of causing deliberate harm, risk of harm and harm that occurs during the performance of beneficial acts. Non-maleficence also means avoiding harm as consequence of good.



### Case Three:

Mr “X” is admitted to internal medicine ward with cardiac failure. The physician admitted Mr “X” and prescribed some medication which should be given regularly by the ward nurse. A nurse in charge of the ward does not give a patient medication timely and appropriately.

**Question:** What should the ward nurse do for Mr “X”

**Time: 5 Minutes**



## 4. JUSTICE

Justice is fair, equitable and appropriate treatment. Justice refers to fair handling and similar standard of care for similar cases; and fair and equitable resource distribution among citizens. It is the basis for treating all clients in an equal and fair way. A just decision is based on client need and fair distribution of resources. It would be unjust to make such decision based on how much he or she likes each client.

### Example:

- Resource scarcity is the common issue in healthcare settings. For example, there may be only one or two neurosurgeons and many patients on the waitlist who need the expertise of these neurosurgeons. In this case we need to serve patients while promoting the principle of justice in transparent way. Example, the rule of first come first serve could be an appropriate rule.
- Justice requires the treatment of all patients equally, irrespective of their sex, education, income or other personal backgrounds.

### 1.2.2. CONFIDENTIALITY AND INFORMED CONSENT.

#### CONFIDENTIALITY

Confidentiality in healthcare ethics underlines the importance of respecting the privacy of information revealed by a patient to his or her health care provider, as well the limitation of healthcare providers to disclose information to a third party. The healthcare provider must obtain permission from the patient to make such a disclosure.

The information given confidentially, if disclosed to the third party without the consent of the patient, may harm the patient, violating the principle of non-maleficence. Keeping confidentiality promotes autonomy and benefit of the patient.

#### THE HIGH VALUE THAT IS PLACED ON CONFIDENTIALITY HAS THREE SOURCES:

- **Autonomy:** personal information should be confidential, and be revealed after getting a consent from the person
- **Respect for others:** human beings deserve respect; one important way of showing respect is by preserving their privacy.
- **Trust:** confidentiality promotes trust between patients and health workers.

#### THE RIGHT OF PATIENT TO CONFIDENTIALITY

- All identifiable information about a patient's health status, medical condition, diagnosis, prognosis and treatment and all other information of a personal kind, must be kept confidential, even after death. Exceptionally, family may have a right of access to information that would inform them of their health risks.
- Confidential information can only be disclosed if the patient gives explicit consent or if expressly provided for in the law. Information can be disclosed to other healthcare providers only on a strictly "need to know" basis unless the patient has given explicit consent.
- All identifiable patient data must be protected. The protection of the data must be appropriate to the manner of its storage. Human substances from which identifiable data can be derived must also be protected.

#### EXCEPTIONS TO THE REQUIREMENT TO MAINTAIN CONFIDENTIALITY

- Routine breaches of confidentiality occur frequently in many healthcare institutions. Many individuals (physicians, health officers, nurses, laboratory technicians, students, etc) require access to a

patient's health records in order to provide adequate care to that person and, for students, to learn how to practice care provision.

- Care providers routinely inform the family members of a deceased person about the cause of death. These breaches of confidentiality are usually justified, but they should be kept to a minimum and those who gain access to confidential information should be made aware of the need not to spread it any further than is necessary for descendants benefit. Where possible, patients should be informed ahead that such a breach might occur.
- Many countries have laws for the mandatory reporting of patients who suffer from designated diseases, those deemed not fit to drive and those suspected of child abuse. Care providers should be aware of the legal requirements to be able to disclose patient information. However, legal requirements can conflict with the respect for human rights that underlies healthcare ethics. Therefore, care providers should look carefully at the legal requirement to allow such an infringement on a patient's confidentiality and assure that it is justified.



#### Case four:

An HIV-positive individual is going to continue to have unprotected Sexual intercourse with his spouse or other partners. **Question:**

1. How do you manage such an individual?
2. Discuss situations that breach confidentiality.

**Time: 5 Minutes**

Ethiopia Council of ministers' regulation 299/2013, Article 77 Professional Confidentiality

## INFORMED CONSENT

Informed consent is legal document whereby a patient signs written information with a complete information about the purpose, benefits, risks and other alternatives before he/she receives the care intended. It is a body of shared decision making process, not just an agreement. Patient must obtain and being empowered with adequate information and ensure that he/she participated in their care process.

For consent to be valid, it must be voluntary and informed, and the person consenting must have the capacity to make the decision. These terms are explained below:

**A. Voluntary:** the decision to either consent or not to consent to treatment must be made by the person him or herself, and must not be influenced by pressure from medical staff, friends or family. This is to promote the autonomy of the patient.

**B. Informed:** the person must be given all of the information in terms of what the treatment involves, including the benefits and risks, whether there are reasonable alternative treatments and the consequences of not doing the treatment. This will help to avoid harm—patients may harm themselves if they decide based on unwarranted and incorrect information.

**C. Capacity:** the person must be capable of giving consent, which means they understand the information given to them, and they can use it to make an informed decision.

## GENERAL PRINCIPLE OF INFORMED CONSENT

Should be given by a patient before any medical treatment is carried out. The ethical and legal rationale behind this is to respect the patient's autonomy and their right to control his or her life. The basic idea of personal autonomy is that everyone's actions and decisions are his or her own.



**The principles include:**

1. Information for patients
2. Timing of consent process
3. Health Professionals responsibility for seeking consent
4. Decision making for incompetent patients
5. Refusal of treatment

Ethiopia Council of minister’s regulation 299/2013, Article 52. Patient’s informed consent

**1.2.3. PREVENTIVE ETHICS IN THE ASPECT OF CRC**

**WHAT IS PREVENTIVE ETHICS?**

Preventive Ethics is a systematic application of ethical principles and values to identify and handle ethical quality gaps, dilemmas, challenges and errors to appropriately and fairly. It could be carried out by an individual or groups in the health care organization to identify prioritize and systematic address quality gaps at the system level.

**WHY IS PREVENTIVE ETHICS IMPORTANT FOR CRC HEALTHCARE WORKERS?**

First and foremost, the CRC health workforce, patients, families and the community at large should have a common understanding that the experience of illness and the practice of medicine lead to situations where important values and principles come to conflict and ethical dilemmas and challenges arise everywhere. Moreover, the CRC health worker should always understand the context in which She/he operates (like the services, the clients, the providers, values, norms, principles, culture, religions, socio-economic-geographic...) as the way in which ethical dilemmas are handled vary from case to case and place to place.

Preventive ethics helps the CRC health workforce to predict, identify, analyze, synthesize and manage ethical dilemmas, challenges and errors to make the appropriate and fair decisions. Hence, preventive ethics enhances honesty and transparency between healthcare workers, patients, families and relevant others to make a deliberated joint decision. Moreover, it inspires mutual understanding and trust amongst the healthcare provider, recipient and the community at large.

Preventive ethics brings all efforts together productively and leads to the satisfaction of clients, providers and the community even if when the decisions are sometimes painful and outcomes are negative.

**1.2.4. ETHICS AND LAW AS ENABLERS OF CRC**

**THE RELATION BETWEEN ETHICS AND LAW**



**Individual reflection**

❖ What is the relationship between ethics and law?

**Time: 5 Minutes**

**ETHICS** as discussed in the previous sessions, is considered as a standard of behavior and a concept of right and wrong beyond what the legal consideration is in any given situation.

**LAW** is defined as a rule of conduct or action prescribed or formally recognized as binding or enforced by a controlling authority. Law is composed of a system of rules that govern a society with the intention of maintaining social order, upholding justice and preventing harm to individuals and property. Law systems

are often based on ethical principles and are enforced by the police and Criminal justice systems, such as the court system.

Ethics and law support one another to guide individual actions; how to interact with clients and colleagues to work in harmony for optimum outcome; provision of competent and dignified care or benefits of clients/ patients. Ethics serves as fundamental source of law in any legal system; and Healthcare ethics is closely related to law. Though ethics and law are similar, they are not identical.

Often, ethics prescribes higher standards of behavior than prescribed by law; and sometimes what is legal may not be ethical and health professionals will be hard pressed to choose between the two. Moreover, laws differ significantly from one country to another while ethics is applicable across national boundaries.

The responsibilities of healthcare professionals and the rights and responsibilities of the patient is stipulated in legal documents of EFMHACA like regulation 299/2013, directives and health facility standards.

### 1.3. PRINCIPLES AND STANDARDS OF COMPASSIONATE CARE

#### 1.3.1. QUALITIES OF COMPASSIONATE CARE

Compassion can be defined as: “sensitivity to the suffering of self and others with a deep wish and commitment to relieve the suffering”.

Developing more compassion can be a way to balance emotions to increase the well-being of patients, healthcare professionals and facilitation of healthcare delivery. For patients, compassion can help prevent health problems and speed-up recovery. Compassion can improve staff efficiency by enhancing cooperation between individuals and teams and between patient and healthcare professionals.



**Individual reflection**  
❖ Can compassion be trained and learned? Time Allowed: 5 Minutes

#### Qualities of Compassionate Care

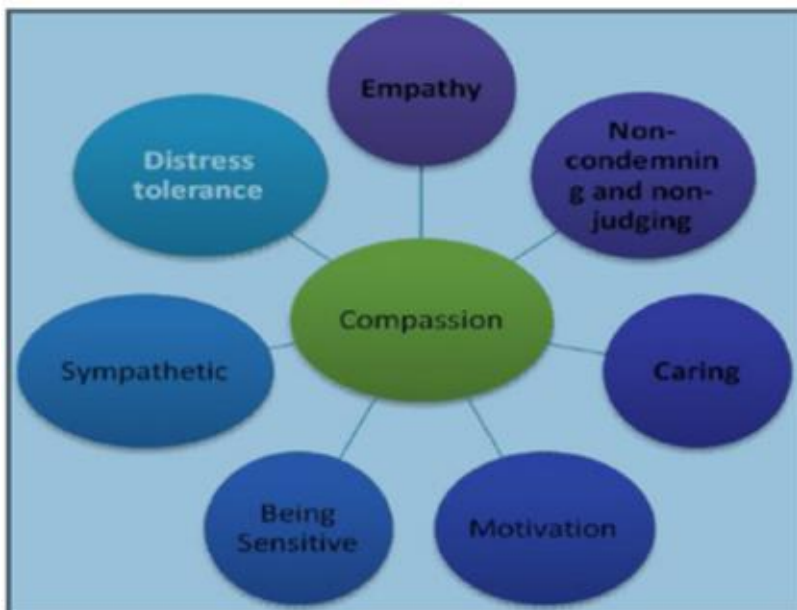



### Role play on qualities of compassionate care:

#### Instructions:

One participant will take the role of a healthcare provider and another participant will take the role of a mother [with limited mobility] of a sick child with a feeding problem. Other participants should observe and note the discussion.

#### Roles

Healthcare provider

A mother (with limited mobility) of a sick child:

#### Situation:

A mother with limited mobility brings her 3-month-old baby girl with cough and fever to the outpatient clinic. The healthcare provider seemed tired. By the time the mother enters the examination room, he was talking with his subordinate about last night's football game. He had already noticed her but did not let her to sit. Her child was crying and she was trying to quiet her.

All of a sudden the healthcare provider shouted loudly at the mother to quiet her child or they would have to leave.

While waiting and calming her child, the mother told the healthcare provider that her child is very sick and needs an urgent care. While facing to his friend, the healthcare provider told the mother that he would see her child in five minutes.

After waiting for 10 minutes, the healthcare provider started to examine the child and felt sad about the condition of the child; apologized to her for having let her wait so long. The healthcare provider evaluated the child gently, gave the child a proper treatment, reassured the mother, and the child went home better.

#### Discussion Questions

Did the health provider demonstrate the characteristics of compassion? If not, what are the areas /conversation that show poor characteristics of compassion?

If yes, what are the areas /conversation that show good characteristics of compassion?

**Time allowed: 30 minutes**

### 1.3.2. ELEMENTS OF COMPASSIONATE CARE

According to researches the key elements of compassionate care has categories, each contains theme and subthemes.

**1. Virtue:** It is described as “good or noble qualities embodied in the character of the health care provider

**2. Relational space:** is defined as the context and content of a compassionate encounter where the person suffering is aware of and is engaged by, the virtues of the health care provider.

## THE CATEGORY OF RELATIONAL SPACE COMPRISED TWO THEMES.

- Patient awareness which describes the extent to which patients intuitively knew or initially sensed health care provider capacity for compassion.
- Engaged care giving which refers to tangible indicators of health care provider compassion in the clinical encounter that established and continued to define the health care provider-patient relationship over time.

**3. Virtuous Response:** It is the “Enactment of a virtue toward a person in suffering,” and it is both an individual category and an overarching principle of care that functions as a catalyst to the three core categories of compassionate care giving: “seeking to understand, relational communicating, and attending to needs” The category of virtuous response contain three broad themes within it:

- Knowing the person refers to the extent to which healthcare providers approached their patients as persons and view their health issues and suffering from this point of view.
- Seeing the person as priority involves healthcare providers’ ability to priorities patient needs, setting aside their own assumptions and healthcare system priorities in the process.
- Beneficence refers to healthcare providers wanting the best for the patient, informing the three more targeted core categories of compassionate care giving.

**4. Seeking to Understand:** refers to healthcare providers trying to know the patient as a person and his or her unique needs.

The need to understand a person’s desires and tailor his or her care is identified by most patients as a fundamental feature of compassion.

- Seeking to Understand the Person.
- Seeking to Understand the needs of the Person

**5. Relational Communication:** is an important element of compassion identified by patients consisting of verbal and nonverbal displays conveyed by the healthcare provider’s engagement with the person suffering.

There are four specific themes and associated subthemes that convey compassion within clinical communication:

- Demeanor (“being”)
- Affect (“feeling for”)
- Behaviors (“doing for”)
- Engagement (“being with”)

## ATTENDING TO NEEDS

It refers to “a timely and receptive desire to actively engage in and address a person’s multi-factorial suffering”. Attending to patients’ needs has three interrelated themes:

- **Compassion-Related Needs:** refers to the dimensions of suffering that patient feel compassion: physical, emotional, spiritual, familial and financial.
- **Timely** refers to addressing suffering in a “timely” manner.
- **Action** refers to the initiation and engagement of a dynamic and tangible process aimed at alleviating suffering. Compassion is more action.

### 1.3.3. PRINCIPLES OF COMPASSIONATE CARE



**Individual reflection**

- ❖ What are the principles of compassionate care?

**Time Allowed: 5 Minutes**

The universal principles of compassion will help us know one another in a more meaningful way where we discover one another respectfully. They create the conditions that allow a person who is suffering to experience the healing power of compassion.

**1. Attention:** is the focus of healthcare provider. Being aware will allow the healthcare provider to focus on what is wrong with a patient; or what matters most to the patient.

**2. Acknowledgement:** is the principle of what the healthcare professional says. The report of the examination or reflection on the patient’s message. Positive messages of acknowledgment are buoyant; they let someone know that you appreciate them as a unique individual.

**3. Affection:** is how healthcare providers affect or touch people. Human contact has the ability to touch someone’s life. It is the quality of your connection, mainly through warmth, comfort, kindness and humor. Affection brings joy and healing.

**4. Acceptance:** is the principle of being with mystery – how you stand at the edge of your understanding or at the beginning of a new experience, and regard what is beyond with equanimity. It is the quality of your presence in the face of the unknown, in the silence. Like the sun in the north at midnight, acceptance welcomes the mysteries of life and is at peace with whom we are and where we are, right now. It is the spirit of Shalom.

- The principle of acceptance is: being at peace with the way things are allows them to change.

### 1.3.4. THREATS TO COMPASSIONATE CARE

There are factors preventing compassion and compassionate behavior for individual members of staff, teams and units and health facility. Most research discusses compassion at the individual level. In general, the most common threats for compassionate care are:

- **Compassionate fatigue:** Physical, emotional and spiritual fatigue or exhaustion resulting from care giving that causes and a decline in the caregivers’ ability to experience joy or feel and care for others.
  - A form of burnout, a kind of “secondary victimization” what is transmitted by clients or patients to care givers through empathetic listening.
- **Unbalanced focus** between biomedical model (clinical training) and person: Effective clinical care is clearly fundamentally important, but human aspects of medicine and care must also be valued in training and in terms of how to be a good healthcare professional.

- Stress, depression and burnout:
  - Self-reported stress of health service staff is reported greater than that of the general working population.
  - Burnout (or occupation burnout) is a psychological term referring to general exhaustion and lack of interest or motivation to work.
- Overall health facility context: Attention by senior managers and health facility boards to achieve financial balance that affects priorities and behaviors of staff in health facility.

### ADDRESSING THREATS OF COMPASSION

- Overcoming compassion fatigue
- Developing an inner compassionate self
- Compassion to yourself
- Teaching compassion to professionals through, training and education
- Dealing with staff stress and burnout
- Dealing with wider health facility context

## 1.4. RESPECTFUL CARE

### 1.4.1. DEFINITION OF CONCEPTS OF RESPECTFUL AND DIGNIFIED CARE

 Think	<b>1. Can you share us your experience with regard to respect and dignity in the health care setting?</b>	
 Pair		<b>2. What does respectful care mean to you?</b>
 Share		<b>Time Allowed: 10 minutes</b>

### Definition of Dignity (Δξάδϛ)

The word dignity originates from two Latin words: ‘dignitus’ which means merit and ‘dignus’ meaning worth. It is defined from two perspectives:

- Dignity is a quality of the way we treat others.
- Dignity is a quality of a person’s inner self.

### Types of Dignity

There are four types of dignity: dignity of human being, personal identity, merit and moral status.

#### 1. Dignity of human being

This type of dignity is based on the principle of humanity and the universal worth of human beings their inalienable rights-which can never be taken away.

#### 2. Dignity of personal identity

This form of dignity is related to personal feelings of self-respect and personal identity, which also provides the basis for relationships with other people.

#### 3. Dignity of merit

This is related to a person’s status in a society.

#### 4. Dignity of moral status

This is a variation of dignity of merit, where some people have a personal status because of the way they perceived and respected by others. (N.B. Refer to Hand-out 3.1 for details.)



## Attributes of Dignity

There are four attributes of dignity:

- 1. Respect:** self-respect, respect for others, respect for people, confidentiality, self-belief and believe in others
- 2. Autonomy:** having choice, giving choice, making decisions, competence, rights, needs, and independence
- 3. Empowerment:** Feeling of being important and valuable, self-esteem, self-worth, modesty and pride
- 4. Communication** (may be verbal or non-verbal): explaining and understanding information, feeling comfort, and giving time to the patients / families

## Definition of Respect (አክብሮት)

- It is a term which is intimately related to dignity
- It is probably the most important action verb used to describe how dignity works in practice.

### THE ACTION MEANINGS OF THE WORD RESPECT ARE:

- Pay attention to
- Honoring
- Avoiding damage e.g. insulting, injuring
- Not interfering with or interrupting
- Treating with consideration
- Not offending

People can vary by their skills, educational background, gender, age, ethnicity, and experiences. But, as human being, all are entitled to get dignified and respectful care. Every human being must respect others and get respect from others. Therefore, dignity is brought to life by respecting people:

- Rights and freedoms
- Capabilities and limits
- Personal space
- Privacy and modesty
- Culture
- Individuals believes of self-worth
- Personal merits
- Reputation
- Habits and values

## DIGNITY AND RESPECT IN THE HEALTH CARE SETTING

Treating clients with dignity implies treating them with courtesy and kindness, but it also means:

- Respecting their rights
- Giving them freedom of choice
- Listening and taking into consideration what they say and
- Respecting their wishes and decisions, even if one disagrees.

Treating clients with dignity implies being sensitive to clients' needs and doing one's best for them, but it also means:

- Involving them in decision making
- Respecting their individuality
- Allowing them to do what they can for themselves and
- Giving them privacy and their own personal space

### 1.4.2. PRINCIPLES OF RESPECTFUL CARE



#### Individual reflection

- ❖ Think of a person who gave you the most respectful care/service.
  - Describe the situation?
  - What are the qualities of that person?
  - What did you value most?

**Time: 5 Minutes**

The principles of respectful care guide actions and responsibility of care providers in ensuring dignified care for their service users. Dignified care has seven core principles.

- Recognize diversity and uniqueness of individuals
- Uphold responsibility to shape care
- Meaningful conversation
- Recognize the care environment
- Recognize factors affecting dignity
- Value workplace culture
- Challenge dignity barriers

### 1.4.3. CHARACTERISTICS OF DISRESPECTFUL CARE



#### The situation where you received disrespectful care?

1. Describe the incident?
2. What was your reaction?

**Time: 5 Minutes**

### THE SEVEN CATEGORIES OF DISRESPECT AND ABUSE

Category	example
Physical Abuse	Slapping, pinching, kicking, slapping, pushing, beating,
Non-consented care	Absence of informed consent or patient communication, forced procedures
Non-confidential care	Lack of privacy (e.g. Laboring in public or disclosure of patient information
Non-dignified care	Intentional humiliation, rough treatment shouting, blaming, treating to withhold services laughed at patients, provider did not introduce themselves, patients not called by their names throughout the interaction.



Discrimination based on specific patient attributes	Discrimination based on ethnicity, age, language, economic status, education level, etc.
Abandonment of care	Women left alone during labor and birth Failure of providers to monitor patients and intervene when needed
Detention in facilities	Detention of patients/family in facility after delivery, usually due to failure to pay

### 1.4.4. FACTORS AFFECTING RESPECTFUL CARE PROVISION



#### Individual reflection

1. What do you think hinders you from providing respectful care in your health facility?
2. What are the factors that facilitates provision of respectful care in your health facilities?

**Time: 5 Minutes**

Different Factors have a significant impact on hindering or facilitating the provision of respectful careservice. These factors can be broadly classified in to three major groups; Health care environment, staff attitude & behavior and patient factors

Positive attributes of the physical environment which helped health professional to provide dignified care are related to aspects maintaining physical and informational privacy and dignity, aesthetically pleasing surroundings and single sex accommodation, toilet and washing facilities. Aspect of the environment that maintain physical and informational privacy are listed below

- Environmental privacy (for example curtains, doors, screens and adequate separate rooms for intimate procedures or confidential discussions (auditory privacy).
- Privacy of the body: covering body, minimizing time exposed, privacy during undressing and clothing are some of the enabling factors to ensure bodily privacy done by health professionals.
- Aesthetic aspects of the physical environment (for example space, color, furnishing, décor, managing smells); and the provision of accommodation, toilet and washing facilities
- Managing peoples in the environment: such as other patients, family and ward visitors/public contribute positively to maintain dignity in the health
- Adequate mix and proficient Staffing: adequately staffed with appropriate number and skill mix, as high workload affects staff interactions, and have strong leaders who are committed to patient dignity.

Physical environment which hinders health professional form providing respectful care are related to the overall health care system, lack of privacy, restricted access to facility /service and lack of resources. Aspect of the environment that hinders the provision of respectful care are listed below,

- The healthcare System: Shortage of staff, unrealistic expectations, poorly educated staff, 'quick fix' attitude, low wage, pay 'lip service' to dignity, low motivation, lack of respect among professionals, normalization/tolerance of disrespectful care, lack of role model, management bureaucracy and unbalanced staff patient ratio and skill mix.
- Lack of privacy: Lack of available single rooms, bath rooms and toilets without nonfunctional locks, use of single rooms only for infectious cases and lack of curtains or screens
- Restricted access to facility/service: Badly designed rooms, inadequate facilities (e.g. toilets, bath rooms), Cupboards with drawers that does not open, toilet and bath rooms shared between male and females.

- Lack of resource: Run out of hospital, gowns and pyjamas, Lack of medical equipment and supplies

The A, B, C, of respectful health care, is a tool designed to consider the attitudes and behaviors of health care providers

### A –ATTITUDE

Ask yourself:

- How would I be feeling if I was this person?
- Why do I think and feel this way?
- Are my attitudes affecting the care I provide and, if so, how?
- Are my personal beliefs, values, and life experiences influencing my attitude?

### ACTION TO BE TAKEN

- Reflect on these questions as part of your everyday practice.
- Discuss provider attitudes and assumptions and how they can influence the care of patients with the care team.
- Challenge and question your attitudes and assumptions as they might affect patient care
- Help to create a culture that questions if and

### B- BEHAVIOR

- Introduce yourself. Take time to put the patient at ease and appreciate their circumstances.
- Be completely present. Always include respect and kindness.
- Use language the patient/family can understand

### C-COMMUNICATION

- Communication revolving around the patient's needs.
- Patient centered communication with defined boundaries

### TEN MECHANISMS TO MITIGATE THREATS TO RESPECTFUL CARE -

1. Support clients with same respect you would want for yourself or a member of your family
2. Have a zero tolerance of all forms of disrespect
3. Respect clients' right to privacy
4. Maintain the maximum possible level of independence, choice, and control
5. Treat each client as an individual by offering personalized care
6. Assist clients to maintain confidence and a positive self esteem
7. Act to alleviate clients' loneliness and isolation
8. Listen and support clients to express their needs and wants
9. Ensure client feel able to complain without fear of retribution
10. Engage with family members and care givers as care partners?

## 1.5. COMPASSIONATE LEADER

### 1.5.1. QUALITY OF COMPASSIONATE LEADERSHIP



#### Group exercise

Discuss in a group of 4-5 and share your experience to the larger group.

- What does it mean for you to lead, and manage?
- Can you give an example of a leader whom you know in your professional or personal life? What makes him or her good leader for you?
- Do you know of any individuals in high positions or authority who demonstrate compassionate, respectful and caring practices when they deal with their staff and clients?

**Duration: 20 minutes**

### BRIEF DESCRIPTION OF LEADERSHIP THEORIES

Introduces transactional, transformational, and servant leadership theories. It will also provide a better understanding of qualities of CRC leaders, which will enable participants to provide better service and increase awareness of CRC leadership.

- **Transformational leaders:** lead employees by aligning employee goals with their goals. Thus, employees working for transformational leaders start focusing on the company's well-being rather than on what is best for them as individual employees.
- **Transactional leaders:** ensure that employees demonstrate the right behaviors because the leader provides resources in exchange.
- **Servant Leadership:** defines the leader's role as serving the needs of others. According to this approach, the primary mission of the leader is to develop employees and help them reach their goals. Servant leaders put their employees first, understand their personal needs and desires empower them and help them develop their careers.

### CHARACTERISTICS OF COMPASSIONATE LEADERS

- 'In-tune' feeling: Their actions abide by their words – and they always have the time to engage with others.
- Manage their moods: They know feelings affect others and they use positive emotions to inspire, not infect others with negative feelings.
- Put people before procedures: They are willing to set aside or change rules and regulations for the greater good.
- Show sincere, heartfelt consideration: They genuinely care for the well-being of others and have a humane side that puts other people's needs before theirs.
- Are mindful: They are aware of their own feelings and their impact on others. They are also attentive and sympathetic to the needs of others.
- Are hopeful: They move others passionately and purposefully with a shared vision that focuses on positive feeling of hope.
- Courage to say what they feel: They communicate their feelings, fears, even doubts which builds trust with their employees.
- Engage others in frank, open dialogue: They speak honestly with humility, respect and conviction, and make it safe for others to do the same.

- Connective and receptive: They seem to know what other people are thinking and feeling.
- Take positive and affirming action: They carry out compassion. They do not just talk about it; they make a promise, act on it and keep it.

### **WHAT DOES COMPASSIONATE LEADERSHIP DO FOR THE ORGANIZATION?**

- Positively affects sufferers, clients, employees
- Increases people's capacity for empathy and compassion
- Promotes positive relationships
- Decreases the prevalence of toxic viral negative emotions and behavior
- Increases optimism and hope
- Builds resilience and energy levels
- Counteracts the negative effects of judgment and bias

### **SELF-EVALUATION OF COMPASSIONATE BEHAVIOR**

Good leaders can evaluate their own behavior using different methodologies. The self-assessment of compassionate leaders should be conducted every six months to enhance self-compassion through mindfulness.

Mindfulness begins with self-awareness: knowing yourself enables you to make choices how you respond to people and situations. Deeper knowledge about yourself enables you to be consistent, to present yourself authentically. You will learn and practice different ways to develop mindfulness and explore how it can contribute to developing compassionate leadership practices through:

- Enhancing attention and concentration
- Increasing creativity and flexibility
- Working efficiently in complex systems and uncertain environments
- Creating meaning and purpose
- Making effective and balanced decisions
- Responding effectively to difference and conflict
- Acting with compassion and kindness
- Enhancing relationships and partnerships
- Enabling genuine and courageous action
- Working ethically and wisely
- Developing cultural intelligence

## 1.5.2. SYSTEMS THINKING FOR CRC



### Group activity in healthcare system thinking

Discuss in a group of 4-5 and share your experience to the larger group.

- Discuss concepts of Health System and how it relates with your Health Facility /Hospital and Health Center/ functions.
- Take your Health Facility/Hospital and Health Center/ and list the various department/core processes/support processes. Using a systems thinking approach, discuss how they interact with each other?
- Take in to account the CRC concepts and identify gaps you may have experienced in your facilities?

**Duration: 20 minutes**

**System:** A system is a set of interacting or interdependent components forming an integrated whole. Health System: A health system consists of all the organizations, institutions, resources and people whose primary purpose is to improve health.

**Fully functional health system:** A point which various management systems and subsystems are connected and integrated to provide the best possible health services to all the intended beneficiaries of those services.

**Management systems:** The various components of the overall health system that managers use to plan organize and keep track of resources. Management systems are run by people living in different contexts.

### INTEGRATE CRC INTO EXISTING SYSTEM

Integration of new initiatives into existing system has paramount importance in expediting the process of implementation and ensuring sustainability of CRC in a health system. Integration can be done using “AIDED” model.

**Assess:** Understand the capacity of the unit structure, especially in regards to the availability of resources, as well as human resource; also to assess the level of human capability when integrating and sustaining the CRC by determining the level of support the unit requires before or after carrying out CRC.

**Innovate:** Design and package the CRC to fit with the existing quality of unit structure and their environmental context to spread the CRC throughout the hospital departments.

**Develop:** Build upon existing knowledge of main stakeholders and opinion leaders by encouraging hospital policies, organizational culture, and infrastructure to support the implementation of principles of CRC.

**Engage:** Use existing roles and resources within the hospital units to introduce, translate, and integrate CRC principles into each employee’s routine practices.

**Devolve:** Capitalize on existing organizational network of index user groups to release and spread the innovation to new user groups.

### 1.5.3. ORGANIZATIONAL CULTURE

Organizational culture consists of the values and assumptions shared within an organization. ~~Organizational culture directs everyone~~ in the organization toward the “right way” to do things. It frames and shapes the decisions and actions of managers and other employees. As this definition points out, organizational culture consists of two main components: shared values and assumptions.

1. Shared Values: are conscious perceptions about what is good or bad, right or wrong. Values tell us what we “ought” to do. They serve as a moral guidance that directs our motivation and potentially our decisions and actions.
2. Assumptions: are unconscious perceptions or beliefs that have worked so well in the past that they are considered the correct way to think and act toward problems and opportunities.

**Five key systems influence the hospital’s effective performance with respect to improving the safety and quality of patient care, as well as sustaining these improvements. The systems are:**

1. Using data
2. Planning
3. Communicating
4. Changing performance
5. Staffing

### LEADERS CREATE AND MAINTAIN A CULTURE OF SAFETY AND QUALITY THROUGHOUT THE HOSPITAL. RATIONALE

- CRC thrives in an environment that supports teamwork and respect for other people, regardless of their position in the organization.
- Leaders demonstrate their commitment to CRC and set expectations for those who work in the organization. Leaders evaluate the culture on a regular basis.
- Leaders encourage teamwork and create structures, processes, and programs that allow this positive culture to flourish. Disruptive behavior that intimidates others and affects morale or staff turnover can be harmful to patient care.
- Leaders must address disruptive behavior of individuals working at all levels of the organization, including management, clinical and administrative staff, licensed independent practitioners, and governing body members.

### CREATING AN ORGANIZATIONAL CULTURE OF EMPOWERING EMPLOYEES FOR CRC

Having empowered employees is the aim of many leaders. Literature has reported that creating an organizational culture will empower employees to increase customer satisfaction levels, as well as to improve employee morale and productivity.

Employee empowerment encourages communication, participation in shared decision-making and enabling physicians and staff to reach their full potential by creating an optimal healing environment.

There are many different ways to build employee empowerment and engagement, but all share six fundamental actions to promote CRC on the part of leadership:

**Share information and communication:** Sharing information with employees is important because it not only helps to build trust; it gives employees important information to allow them to make the best possible decisions in critical situations when providing CRC services.



**Create clear goals and objectives:** Inspire employees to embrace the mission or changes of the organization by appealing to their innate desire to help patients and provide an efficient CRC service. Great leaders share important information in a structured and consistent manner.

**Teach, accept and encourage:** If you empower employees to make decisions that will help keep customers happy, then you have to be willing to allow them to make mistakes and learn from those mistakes.

**Reward Self-Improvement:** Create an environment that celebrates both successes and failures. A good leader celebrates successes; and employees who take risks for the benefits of patients/client; also, a good leader will assist employees to develop a plan for growth and reward them as they advance.

**Support a learning environment:** Listen to the voice of physicians, nurses and other staff to understand key barriers, issues, and opportunities to allow them to have a voice in crafting solutions for CRC challenges.

**Create a clear role of autonomy:** Enable frontline workers to execute change by supplying resources (education, funding, access to other skill sets within the health facility, etc.) and removing obstacles themselves.

#### 1.5.4. LEADING CRC HEALTH TEAMS



##### Group activity

Discuss in a group of 4-5 and share your experience to the larger group.

- What principles do you think of when implementing CRC?
- Do you think there are differences between your current “leading” style and leading based on CRC? If yes, list the differences.

**Duration: 10 minutes**

Health facility leaders have intersecting roles as public servants, providers of health care, and managers of both healthcare professionals and other staff.

- As public servants, health facility leaders are specifically responsible for maintaining the public trust, placing duty above self-interest and managing resources responsibly
- As healthcare providers, health facility leaders have a fiduciary obligation to meet the healthcare needs of individual patients in the context of an equitable, safe, effective, accessible and compassionate health care delivery system.
- As managers, leaders are responsible for creating a workplace culture based on integrity, accountability, fairness and respect.

#### ETHICAL HEALTHCARE LEADERS APPLY AT LEAST THE FOLLOWING SIX SPECIFIC BEHAVIORAL TRAITS:

- 1. Ethically conscious:** Have an appreciation for the ethical dimensions and implications of one’s daily actions and decisions or, as described by author John Worthily, the “ethics of the ordinary” (reference?).
- 2. Ethically committed:** Be completely devoted to doing the right thing.
- 3. Ethically competent:** Demonstrate what Rush worth M. Kidder, president and founder of the Institute for Global Ethics, calls “ethical fitness,” or having the knowledge and understanding required to make ethically sound decisions (reference).

4. **Ethically courageous:** Act upon these competencies even when the action may not be accepted with enthusiasm or endorsement.
5. **Ethically consistent:** Establish and maintain a high ethical standard without making or rationalizing inconvenient exceptions. This means being able to resist pressures to accommodate and justify change inaction or a decision that is ethically flawed.
6. **Ethically candid:** Be open and forthright about the complexity of reconciling conflicting values; be willing to ask uncomfortable questions and be an active, not a passive, advocate of ethical analysis and ethical conduct.

## PROBLEM-SOLVING IN HEALTHCARE

### Steps of Scientific Problem Solving Skills

1. Define the problem
2. Set the overall objective
3. Conduct a root cause analysis
4. Generate alternative interventions
5. Perform comparative analysis of alternatives
6. Select the best intervention
7. Develop implementation plan and implement plan
8. Develop evaluation plan and evaluate

## BEST PRACTICE IDENTIFICATION

### Criteria to select best practices

- New/Novel idea- not much practiced in other hospitals in Ethiopia
- **Effectiveness:** has brought empirical change to the implementation of CRC specifically to patient satisfaction and quality of service provision. The practice must work and achieve results that are measurable.
- **Relevant/impact:** improved CRC and quality of patient experience (Explain the relevance of the innovation using a clear baseline and current performance of CRC)
- **Diffusible:** implemented at low cost in other facilities or implemented innovation in other hospitals.
- **Sustainable:** Innovation is easy to understand, easy to communicate and works for long time.
- **Political commitment:** The proposed practice must have support from the relevant national or local authorities.
- **Ethical soundness:** The practice must respect the current rules of ethics for dealing with human populations.

By definition, “Best Practices” should be “new/novel”, “effectiveness” and “relevance”.

## MONITORING AND EVALUATION OF CRC HEALTH TEAM

### Potential focus areas where leaders focus to evaluate their CRC staff

- **Quality of work:** Provide accuracy and thorough CRC service
- **Communication and interpersonal skills:** listening, persuasion and empathy to clients/patients and teamwork and cooperation in implementing CRC
- **Planning, administration and organization:** setting objectives, and prioritizing CRC practice



- **CRC knowledge:** knowledge-base training, mentoring, modeling and coaching
- **Attitude:** dedication, loyalty, reliability, flexibility, initiative, and energy towards implementing CRC
- **Ethics:** diversity, sustainability, honesty, integrity, fairness and professionalism
- **Creative thinking:** innovation, receptiveness, problem solving and originality
- **Self-development and growth:** learning, education, advancement, skill-building and career planning

## 1.6 SUMMARY

- Dignity of human being is the basis for healthcare delivery
- Clients should be treated as human being not as cases
- Disrespect and abuse is a problem in Ethiopia.
- Zero Tolerance to Disrespectful care shall be a motto for all health workers in the health facilities.
- Improving the knowledge of ethics is important to boost the ethical behavior in practice

# Chapter 2:

## Infant incubator

### CHAPTER DESCRIPTION:

This Chapter describes MCH medical devices designed to equip biomedical engineers/technicians to maintain MCH medical equipment's specifically infant incubators.

### PRIMARY OBJECTIVE:

At the end of this chapter the participants will be able to:

- Maintain infant incubator based on the acquired knowledge, skill and attitude.

### SPECIFIC OBJECTIVES:

At the end of this chapter the participants will be able to:

- Describe purpose of infant incubator
- Explain working principle of infant incubator
- Differentiate basic parts and function of infant incubator
- Perform troubleshooting of infant incubator
- Perform preventive ,curative maintenance and performance test of infant incubator
- Perform calibration of infant incubator
- Practice safe handling of infant incubator

### CHAPTER OUTLINE

- 2.1. Introduction
- 2.2. Working principle of infant incubator
- 2.3. Incubator component's function
- 2.4. Basic parts and function of infant incubator
- 2.5. Safety and care of the device
- 2.6. Troubleshooting techniques
- 2.7. Maintenance and Repair procedure
- 2.8. Preventive Maintenances
- 2.9. Summary

## 2.1. INTRODUCTION

Infant incubator is a medical device which provides Warmth, Humidity and Oxygen all in a controlled environment by circulating heated air over the skin, the heat is then absorbed into the body by tissue conduction and blood Convection. Ideally, both the skin and core temperatures should be maintained with only minor variations.



**Group activity 2.1**

- ❖ Explain the purpose and clinical applications of infant incubator

**Time Allowed: 5 Minutes**

Figure 1. infant incubator

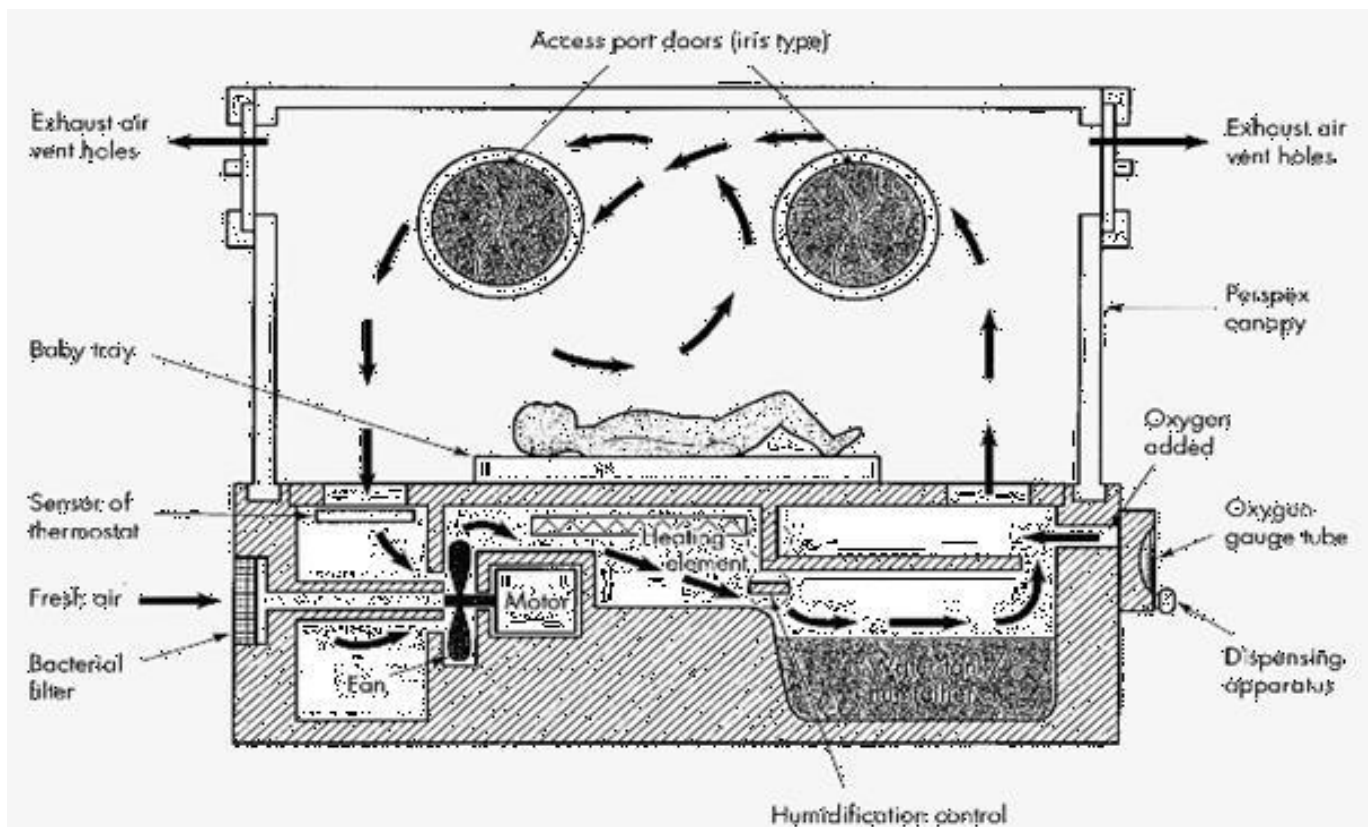

### 2.1.1 PURPOSE / CLINICAL APPLICATION

Infant Incubator is generally used to provide a safe and stable environment for newborn infants, often those who were born prematurely or with an illness or disability that makes them especially vulnerable for the first several months of life.

Infant incubator provides Protection, as fully enclosed and controllable environments; incubators can be used to protect babies from a wide range of possible dangers.

Oxygenation is a therapeutic process in which oxygen is administered directly to facilitate breathing. Oxygenation is often administered via the infant incubator environment as a treatment for infant respiratory distress syndrome

Monitoring and observation equipment is often built into the infant incubator unit; these instruments can include cardiac monitors, brain-scan equipment, blood-monitoring equipment, thermometers and other instruments for observing vital signs.

## 2.2. WORKING PRINCIPLE

- ✓ An infant incubator is normally in the form of a trolley with a small mattress on the top covered by a rigid clear plastic cover.
- ✓ Incubator chamber provides a clean environment, and helps to protect the baby from noise, dust, infection, and excess handling.
- ✓ Then, a temperature sensor is taped to the baby's skin, and the incubator heater adjusts to maintain the baby at a constant temperature or, the temperature is controlled by a thermostat in the heated air stream.
- ✓ Underneath the baby is an air-blown electric heating system and humidification system which circulates heated humid air at a desired temperature and humidity through the incubator chamber.
- ✓ Additional oxygen may also be introduced into the chamber if it is needed.

Figure 2. Block diagram of Infant Incubator

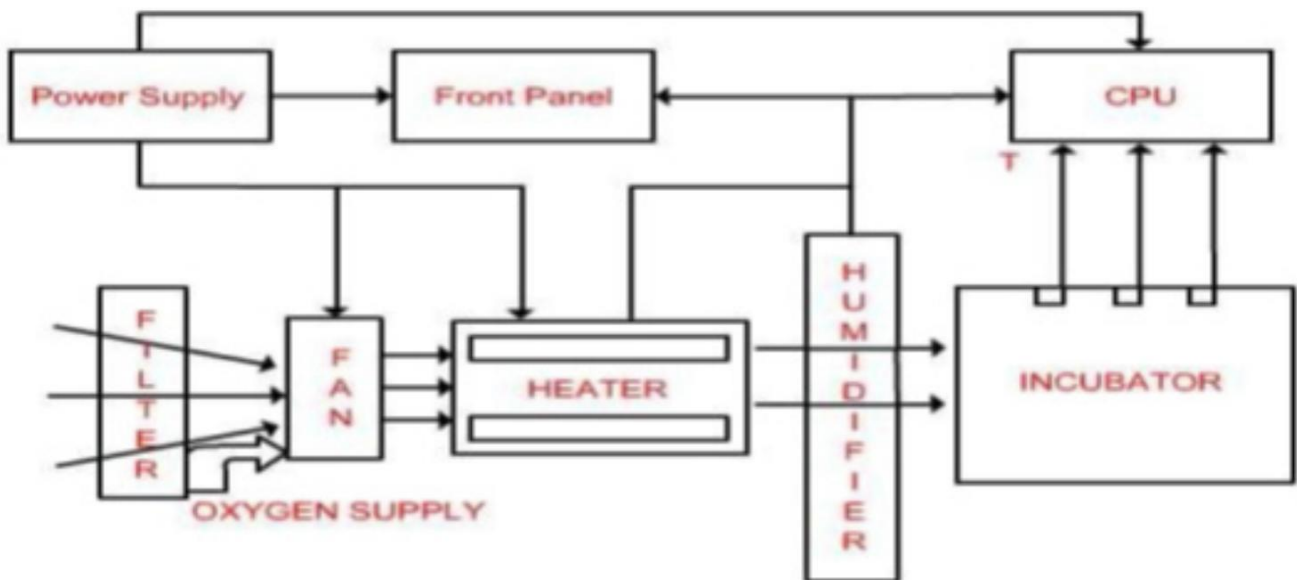

### Group activity 2.1

#### Learning activity 2.2

Discuss the working principle of infant incubator and the function of (incubator chamber, temperature sensor, thermostat, electric heating system and humidification system.

5 Mns

## 2.3. BASIC PARTS AND FUNCTION

### 2.3.1 THE MAJOR COMPONENTS OF AN INFANT INCUBATOR SYSTEM ARE:

1. Main body
2. Control panel
3. Hand inlet with sleeves
4. Access door with lock
5. Baby board/tray with a mattress.
6. Thermostat
7. Cable with top plug.

- 8. On/Off Switch.
- 9. Humidifier tray
- 10. Fresh air inlet/outlet.
- 11. Thermometer
- 12. Bulbs/lamps
- 13. Oxygen inlet.
- 14. Skin sensor

### 2.3. 2. FUNCTION OF INCUBATOR COMPONENTS

**Power Supply:** This provides the necessary voltage for the operation of the Incubator

**Main body:** Contains main parts

**Control panel:** used to interface with the machine to get the desired operation and Contains The control buttons .

**Access door with lock:** Door to open/close the chamber

**Baby board/tray with a mattress:** Baby care unit

**Filter:** protect the infant from airborne bacteria and other impurities

**Fan:** is used to circulate air in the Incubator

**On/Off Switch:** Button to turn on/off

**Humidifier:** The heated airs pass through the humidifier to be humidified to desired level

**Fresh air inlet/outlet:** To allow air to enter/out

**Thermometer:** To measure the room temperature

**Bulbs/lamps:** For lighting purpose during examination

**Oxygen inlet:** To allow oxygen to enter

**Skin sensor:** To detect the skin temperature



#### Learning activity 2.3: Group

List the major components of infant incubators and discuss about their functions

5:Mns

### 2. 4. CLASSIFICATION

**Portable:** Easily movable from place to place.

**Fixed:** Installed at a fixed place.

#### Learning activity 2.4: Individual activity

List and discuss the major classification of infant incubators

## 2.5. SAFETY AND CARE OF THE DEVICE

- ✓ Do not leave any patient inside the Incubator unattended for a long time.
- ✓ Humidifier compartment should be fixed even if it is not used.
- ✓ Do not place the Infant Incubator in direct sunlight or other source of light as it might overheat the infant.
- ✓ If ambient temperature is higher than the set value then Incubator will be in effective.
- ✓ When oxygen is administered always check the level using an independent oxygen monitor
- ✓ Never oil or grease the oxygen inlets if Incubator is cleaned with flammable agents like ether, alcohol etc, it should be air dried before being put to use.
- ✓ The air filter should not be cleaned and should be replaced at least every three months or when it is dirty.
- ✓ Avoid moisture or contact with water, excessive humidity and temperature. The Incubator should be kept in a clean and dry place whenever not in use.



### Learning activity 2.5: Individual activity

List the appropriate safe handling procedures for infant incubator

3:Mns

## 2.6. TROUBLESHOOTING TECHNIQUES

### 2.6.1. PREPARATORY STEPS OF TROUBLESHOOTING TECHNIQUE

Before directly the conducting trouble shooting technique one has to perform the following tasks:  
Receive maintenance request

- o Prepare
- o PPE (personal protective equipment )
- o Cleaning material
- o Melt meter to check electrical parameters
- o Mechanical and electrical tool kits to trouble shoot
- o Service manual
- o Checklists to check qualitative and quantitative data
- o Gather information about the equipment and the problem
  - Understand the equipment's design and operation
  - Draw out or locate schematic of device
  - Obtain and review history records to check for any recurring problems

## PHYSICAL INSPECTION

- Observe state of all components, for example:
- Relays energized or not
- Which lamps are lit
- Auxiliary equipment running or not
- Look for obvious visual clues to the cause

- Evidence of mechanical damage:
- Impact
- Chafed wires
- Loose components
- Parts lying in bottom of chamber
- Overheating: Wiring
- Smell: Burned insulation/wiring
- Sound: To find the problem area and Can indicate mechanical failures
- Touch (Carefully!); Hot areas indicate over heating o check status of Dust and Bacterial filter

## 2.6.2. TROUBLESHOOTING PROCEDURES TO DETECT MAJOR COMPONENT

### FAILURES I. power supply check up

- o check if there is a power from power out let , power supply cable and trace all power flowing path
- o check the electrical status of
  - Air temperature control
  - Infant temperature control
  - Integral humidification
  - Access doors
  - Alarm system

### II. Check the status of all sensors

- ✓ Check the status of temperature sensor, oxygen sensor, humidifier sensor, display unit and the connection with patient probe

### III. Check fan and motors for proper functioning

- ✓ Check the proper function of fans and motors by measuring input/output voltage, continuity, etc... using digital melt meters.

### IV. Check the status of heating element

- ✓ Check the proper function of heating element using digital melt meters and measure continuity, input/output voltage.

### V. Test if the battery is functional

- ✓ Check the proper function of battery using digital melt meters, and measure input/output voltage.



#### Group activity 2.7

Arrange yourself in a group where each group can have a maximum of five trainers and perform a troubleshooting activity on the following system components of an infant incubator.

- Power supply unit
- All sensors
- Fan and motors
- Heating element
- Battery



## 2.7. MAINTENANCE AND REPAIR PROCEDURE

Symptoms	Probable causes	Solutions Symptoms
The machine not turned on	Loose connection	Tight the power cable properly
	No power	Check the power /from wall outlet
	Burnt cables	fix/ change it
Low air through the chamber	Dust filters might be dirty	Replace dust filter
	Bacterial filters dirty	Replace bacterial filters
Failure in Air temperature control	Temperature not set	Reset temperature
	Board burnt	Fix/change temperature circuit board
Failure in infant temperature control	Loose temperature sensor	Check on the temperature sensor
	Temperature sensor Damaged/worn out	Replace with new one
Failure in integral humidification	Humidifier sensor fail	Change the humidifier sensor
	No distilled water	Add distilled water, if no water
Failure in access doors/ port	Mechanically broken/ cracked	Fix /change broken /cracked door/ port
The Infant Incubator not run	The machine not turned on	Turn on the system/ make sure if the battery is functional
	No power from power out let	
	power supply cable failure	Fix/Change another power cable
	power flowing path component defect	maintain or replace components including fuses
failure in temperature sensor	Loose connection	Tight it properly
	Inappropriate temperature sensor	fix/change temperature sensor
oxygen sensor failure	Exhausted sensor	change oxygen sensor
If there is a failure of display unit	No power	Check and fix the power
	Display control board fail	trace the display control board and substitute or fix any defected components including data cables Patient/temperature probe, and fix/change
high oxygen concentration	Filters/ fans problem	Check the air filter and fan and replace if filters are dirty and clean fan.
low oxygen concentration	access door and air inlet filter problem	the position of access door and air inlet filter should be fixed
If there is an alarm in air flow	Air block/fan motors failed	Clear the blockage in air outlet or if fan motor is failed replace it.
If there is high temperature concentration	seat gasket problem	fit/fix hood seat gasket properly
If there is low temperature concentration	access door/skin probe connection problem	Close access door and check skin probe connection.
If there is no heat inside the incubator	Heating element burnet	replace heating element





### Learning activity 2.7

Arrange yourself in a group where each group can have a maximum of five trainers. Trainers will arrange nine different maintenance scenarios per group on a set of different infant incubator. Each maintenance scenarios are created by creating fault on infant incubators due to different system component failures (use maintenance and repair table as reference). The maintenance scenarios are due to one of the following system component failures; i.e. failures due to:

- Power unit failure
- Temperature control
- Integral humidification
- Oxygen sensor
- Access door/skin probe connection failure
- Bacterial and dust filter failures
- Fan and motor failure
- Heating element failure
- Gasket problem

Then within your group perform a troubleshooting activity and repair the failures of each of the six patient monitoring devices.

**15:Mns**

## 2.8. PREVENTIVE MAINTENANCES

- ✓ Cleaning Fan, Filters/ Replace
- ✓ check & calibrate Sensors
- ✓ Safety test & all other functional check
- ✓ Bearings of Motor (Fan)
- ✓ Heater coil resistance & its contacts
- ✓ Casters & Wheels Consumables- Iris Port covers, sensors, Air Filters

### Cleaning procedure

- ✓ Cleaning should be done at least once a week or every time the patient is changed.
- ✓ The heater rod can be hot enough to cause severe burns. So switch off the machine, unplug the power cord and allow the unit to cool down before disassembly or cleaning.
- ✓ Clean all porthole seals and Hood seals parts with a solution of general purpose neutral detergent and warm water.
- ✓ Clean frame, mattress and accessories with a solution of general purpose neutral detergent and warm water, applied with a disposable wipe.
- ✓ Clean the oxygen inlet with mild cleaning solution.
- ✓ Reusable Patient probes can be cleaned by soaking the probe tip and wire in a cleaning solution.

### Disinfection

- ✓ If the incubator used by infected babies, after cleaning, wipe over with a chlorine-releasing agent rinse and dry thoroughly.

- ✓ If there is contamination with blood or faces, clean then wipe it with a chlorine releasing agent, rinse and dry.
- ✓ Phenolics or alcohols should not be used as they will damage the waterproof coating of the mattress cover



### Learning activity 2.8

What are the major preventive maintenance procedures that are commonly applied on infant incubators?

3:Mns

## 2.9. PERFORMANCE TEST FOR INFANT INCUBATOR

Check point	Check content	Result	
		Yes	No
1. physical	All external components are statted properly		
2. filters	Dust filter and bacterial filters are clean		
3. electrical unit	Turn on the machine and check the machine is running		
4. sensor	temperature sensor, oxygen sensor and humidifier sensor are working		
5. oxygen and temperature level	Oxygen and temperature concentration are accurate		
6. heating element	Chamber is getting heat		
7. battery	Battery is functional		

### 2.10 Summary

- Infant incubator is a medical device which provides Warmth, Humidity and Oxygen.
- Infant incubator provides fully enclosed and controllable environments.
- Incubator chamber helps to protect the baby from noise, dust, infection, and excess handling.
- Portable: Easily movable from place to place.

#### Classifications of Infant Incubator

- Portable: Easily movable from place to place.
- Fixed: Installed at a fixed place.

#### Troubleshooting procedures to detect major component failures

- power supply check up
- Check the status of all sensors
- Check fan and motors for proper functioning
- Check the status of heating element
- Test if the battery is functional

# Chapter 3:

## Infant radiant warmer

### CHAPTER DESCRIPTION:

This Chapter describes MCH medical devices designed to equip biomedical engineers/technicians to maintain MCH medical equipment's specifically infant radiant warmer.

### PRIMARY OBJECTIVE:

At the end of this chapter the participant will be able to:

- Maintain infant radiant warmer based on the acquired knowledge, skill and attitude.

### SPECIFIC OBJECTIVES:

At the end of this chapter the participant will be able to:

- Describe purpose of Infant radiant warmer
- Explain working principle of Infant radiant warmer
- Differentiate basic parts and function of Infant radiant warmer
- Perform troubleshooting of Infant radiant warmer
- Perform preventive ,curative maintenance and performance test of Infant radiant warmer
- Practice safe handling of Infant radiant warmer

### CHAPTER OUTLINE

- 3.1.Introduction
- 3.2.Purpose of Infant Radiant Warmer
- 3.3. Working principle of Infant Radiant Warmer
- 3.4. Basic parts and function
- 3.5. Infant radiant warmer components function
- 3.6. Classification of Infant Radiant Warmer
- 3.7. Safety and care of the device
- 3.8. Troubleshooting techniques
- 3.9. Maintenance and repair
- 3.10. Summary

### 3.1. INTRODUCTION

Radiant warmer is a microprocessor controlled unit with heater placed on the overhead panel. It consists of a biocompatible bed on which to place the infant, and an overhead heater that delivers radiant heat. A skin temperature probe monitors infant temperature. Heat output can be controlled manually or through baby mode (feedback mode) for thermoregulation. Visual and audio alarms are present for safety. Infant radiant warmer is intended to maintain the thermal balance of an infant by direct radiation of energy in the infrared region of the electromagnetic spectrum



### 3.2. PURPOSE / CLINICAL APPLICATION

Infant radiant warmer is medical equipment used for keeping the babies warm and maintaining the body temperature. These devices are commonly used to provide thermal support for newborns in the delivery suite, for critically ill infants who require constant nursing intervention, and for infants undergoing treatment that prolongs exposure to a cool environment. Prolonged cold stress can overwork heat producing mechanisms, drain energy reserves, and result in hypoxia, acidosis, hypoglycemia, and, in severe cases, death.



#### Learning activity 3.1: Group or individual?

Explain the purpose and clinical applications of infant radiant warmer

Time: 5mns

### 3.3 WORKING PRINCIPLE

- The heating element generates a significant amount of radiant energy in the far IR wavelength region (longer than three microns to avoid damaging the infant's retina and cornea). The radiant output of the heating unit is also limited to prevent thermal damage to the infant.
- The IR energy is readily absorbed by the infant's skin; increased blood flow in the skin then transfers heat to the rest of the body by blood convection (heat exchange between the blood and tissue surfaces) and tissue conduction(heat transfer between adjacent tissue surfaces)..

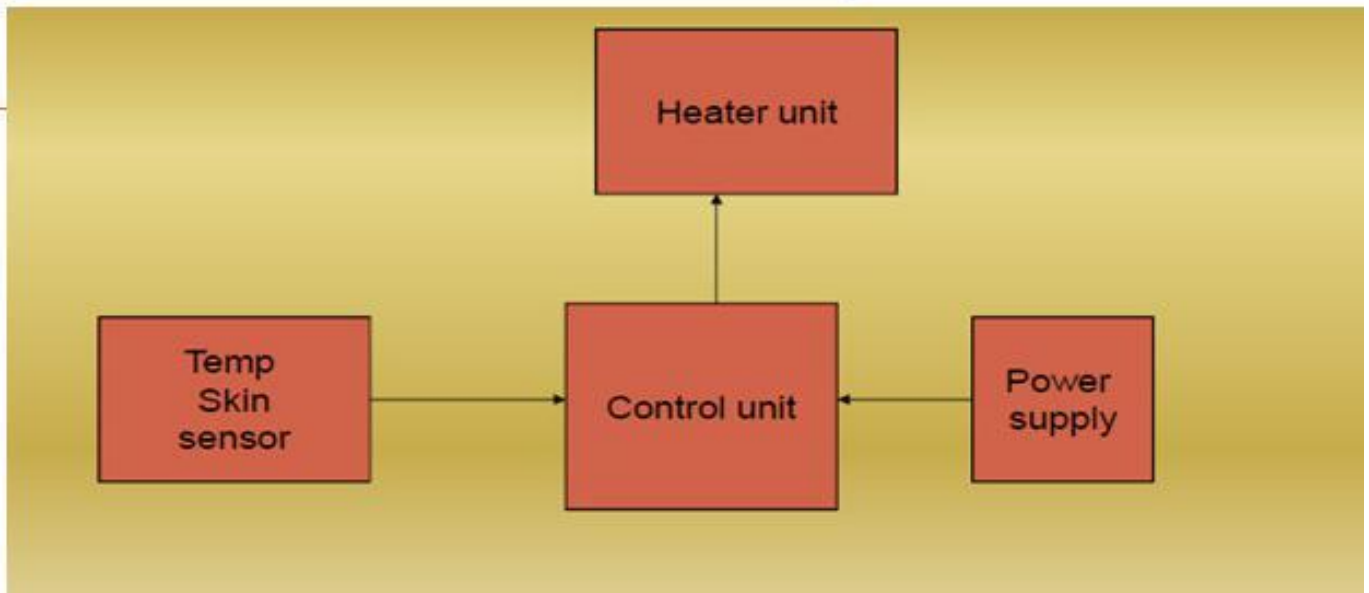



Figure 4. block diagram of Infant radiant warmer



**Learning activity 3.2: Discuss the working principle of infant radiant warmer (heating element, temperature sensor, control unit and power supply)**  
2:Mns

### 3.4 BASIC PARTS AND FUNCTION OF INFANT RADIATOR WARMER

1. Cable with top plug
2. Power on/off switch
3. Power indicator lamp
4. Heater Module or Halogen Bulb
5. Heater Output Control
6. Skin sensor
7. Pillars/Bars
8. Retaining screw for fixing the pillar
9. Slide base bracket/slide panels
10. Conductive mattress
11. Knobs for tilting the table
12. Treatment table
13. Bassinet (slide pad)
14. Shelf
15. Drawer with a resuscitation set
16. Pedestal/Casters

### 3.5. INFANT RADIANT WARMER COMPONENTS FUNCTION

**Cable with top plug:** It is power cable and used to transferring power

**Power on/off switch:** Used to switch on/off the machine

**Power indicator lamp:** Indicates the availability of the power

**Heater Module or Halogen Bulb:** Giving lights during/after examination

**Heater Output Control:** To control the amount of heat to be delivered to the infant

**Skin sensor:** To detect/sense the skin temperature

**Pillars/Bars:** Having the displays, On/Off switch, and other parameters

**Conductive mattress:** For infant safety and comfort

**Treatment table:** For infant bed and treatment purpose

**Pedestal/Casters:** For ease of movement of the machine/ Infant Radiant Warmer



**Think-Pair-Share 3.3:**

List the major components of infant radiant warmers and discuss about their functions

**Time :5mns**

### 3.6. CLASSIFICATION

#### Types

**Fixed:** Installed at a fixed place.

**Mobile (Heater and Integral Models):** Easily movable from place to place.



**Learning activity 3.4:**

List and discuss the major classification of infant radiant warmer

**3:Mns**

### 3.7 SAFETY AND CARE OF THE DEVICE

1. Do not use the warmer in the presence of flammable anesthetics; a possible explosion hazard exists under this condition.
2. Do not touch the protective grill under the radiant heater or the top of the heater assembly.
3. Disconnect power to the warmer and allow the heater rod to cool before cleaning to avoid the possibility of a burn.
4. Never oil or grease oxygen equipment. Oils and grease oxidizes readily, and in the presence of oxygen, will burn violently.
5. Do not place items on top of the heater assembly as they can fall and injure the patient.
6. Inspect all patient connected tubes before and after moving the bed as any movement can pull tubing or leads connected to the patient.
7. Prolonged exposure to the light emitted by the observation lamp in this unit may harm the unprotected eyes of the infant. For safety, cover the infant's eyes.
8. Do not use the warmer system if the system failure alarm is activated.
9. When using a radiant warmer, change the patient's diapers frequently.
10. Do not leave the patient unattended while using the warmer.
11. The I.V. pole should not be overloaded –maximum weight 2kg.



**Learning activity 3.5:**

List the appropriate safe handling procedures for infant radiant warmer

**Time: 5mns**

## 3.8. TROUBLESHOOTING TECHNIQUES

### 3.8.1. PREPARATORY STEPS OF TROUBLESHOOTING TECHNIQUE

Before directly the conducting trouble shooting technique one has to first perform the following tasks:

#### Receive maintenance request

- o Prepare
- o PPE(personal protective equipment )
- o Cleaning material
- o Melt meter to check electrical parameters
- o Mechanical and electrical tool kits to trouble shoot
- o Service manual
- o Checklists to check qualitative and quantitative data
- o Gather information about the equipment and the problem
  - Understand the equipment's design and operation
  - Draw out or locate schematic of device
  - Obtain and review history records to check for any recurring problems

#### Physical inspection

- Observe state of all components, for example:
  - Relays energized or not
  - Which lamps are lit
  - Auxiliary equipment running or not
- Look for obvious visual clues to the cause
  - Evidence of mechanical damage:
- Impact
- Chafed wires
- Loose components
- Parts lying in bottom of chamber
  - Overheating
- Wiring
  - Smell
- Burned insulation/wiring
  - Sound
- To find the problem area
- Can indicate mechanical failures
  - Touch (Carefully!)
- Hot areas indicate over heating





**Group activity 3.6:**

Arrange yourself in a group where each group can have a maximum of five trainers and perform a troubleshooting activity on the following system components of an infant radiant warmer.

- Power supply unit
- All sensors
- Heating element

After finishing the troubleshooting identify the system failures/ problems (if there is any) of the device

Time:10Mns

**3.8.2. TROUBLESHOOTING PROCEDURES TO DETECT MAJOR COMPONENT FAILURES**

**I. Power supply check up**

- o check if there is a power from power out let , power supply cable and trace all power flowing path
- o Check the electrical status of Control pane and Phototherapy warning light

**II. Check the status of all sensors**

- ✓ Check the status of temperature sensor, Halogen Bulb ,display unit and the connection with patient probe

**III. Check the status of heating element**

- ✓ Using digital melt-meter check the working status of the heater

**3.9. MAINTENANCE AND REPAIR**

Symptoms	Probable causes	Solutions
<b>The machine not turned on</b>	loose connection	Tight the power cable properly
	No power	Check the power/wall outlet
	Burnt cables	fix/ change it
	power flowing path component defect	maintain or replace components including Internal fuses, mains lead and internal harnesses defective.
<b>Alarm sounding and manual indicator flashing.</b>	Software set up error	Check Software set up and fix problem
	Temperature sensor error	Check the temperature sensor Or fix/ change it
	Other parameters error	Use information mode to obtain error code
<b>Wrong readings</b>	Skin temperature failed	Check if Skin sensor is damaged, and fix it
	Loose connection of sensor cables	Insert it properly
	not the right type	Replace the correct skin sensors

<b>Manual indicator flashing accompanied by rapid pulsing two tone alarm</b>	Defective control board	Check the control board
	Defective power board	Check the power board
	Defective PCB	replace the defective PCB
<b>Failure of display unit</b>	Defective components, including data cables Patient/temperature probe	trace the display control board and substitute or fix it
	Defective of display board	correct/ change the defected components, including data cables Patient/temperature probe
<b>No heat inside baby chamber</b>	Loose Heater connecters	Tight/fix it properly
	Temperature sensor button set to zero	Set temperature sensor button to high
	The heating element is burned	Replace/fix heating element



**Group activity 3.9:**

Arrange yourself in a group where each group can have a maximum of five trainers s. Trainers will arrange five different maintenance scenarios per group on a set of different infant radiant warmer devices. Each maintenance scenarios are created by making the infant radiant warmer devices malfunctioned due to different system component failures. The maintenance scenarios are due to one of the following system component failures; i.e. failures The maintenance scenarios are due to one of the following system component failures; i.e. failures due to:

- o Power unit
- o Cable connection
- o PCB board
- o Heating element
- o Patient temperature probe

Then within your group perform a troubleshooting activity and repair the failures of each of the case infant radiant warmer.

**Time:15mns**

**3.9.1. PREVENTIVE MAINTENANCE PROCEDURE**

- ✓ Turn off the power switch and disconnect power from the mains.
- ✓ Ensure the brake lock is on top to prevent movement of the unit
- ✓ Clean the main frame with a mild detergent solution.
- ✓ The mattress, x-ray grid and side panels may be cleaned without immersing by using a suitable disinfectant agent.
- ✓ Clean the skin temperature probe by gently wiping with a soft, damp cloth containing detergent or disinfecting solution.



**Learning activity 3.9**

What are the major preventive maintenance procedures that are commonly applied in infant radiant warmer devices?

**Time: 5mns**

**3.10. PERFORMANCE TEST FOR INFANT RADIANT WARMER**

Check point	Check content	Result	
		Yes	No
1. physical	All external components are stotted properly		
2. Alarm sounding and manual indicator	Alarm sounding and manual indicator are accurate		
3. electrical unit	Turn on the machine and check the machine is running		
4. sensor	Skin sensor is normal , inserted fully or the right type		
5. heating element	Chamber is getting heat		

**3.11. SUMMARY**

- Radiant warmer is a microprocessor controlled unit with heater placed on the overhead panel.
- Infant radiant warmer is medical equipment used for keeping the babies warm and maintaining the body temperature.

**Classification**

- **Fixed:** Installed at a fixed place.
- **Mobile (Heater and Integral Models):** Easily movable from place to place.

**Troubleshooting procedures to detect major component failures**

- power supply check up
- Check the status of all sensors
- Check fan and motors for proper functioning
- Check the status of heating element
- Test if the battery is functional

# Chapter 4:

## Fetal monitor

### CHAPTER DESCRIPTION:

This Chapter describes MCH medical devices designed to equip biomedical engineers/technicians to maintain MCH medical equipment's specifically fetal monitor.

### PRIMARY OBJECTIVE:

At the end of this chapter the participant will be able to:

- Maintain fetal monitor based on the acquired knowledge, skill and attitude.

### SPECIFIC OBJECTIVES:

At the end of this chapter the participant will be able to:

- Describe purpose of fetal monitor
- Explain working principle of fetal monitor
- Differentiate basic parts and function of fetal monitor
- Perform troubleshooting of fetal monitor
- Perform preventive, curative maintenance and performance test of fetal monitor
- Practice safe handling of fetal monitor

### CHAPTER OUTLINE

- 4.1. Purpose/clinical application
- 4.2. Working principle
- 4.3. Basic parts function
- 4.4. Safety and care of the device
- 4.5. Troubleshooting Techniques
- 4.6. Maintenance and Repair
- 4.7. Performance Test for Fetal Monitor
- 4.8. Summary

### 4.1. PURPOSE / CLINICAL APPLICATION

Fetal monitoring provides graphic and numeric information on fetal heart rate (FHR) and maternal uterine activity (UA) to help clinicians assess fetal well-being before and during labor.

Fetal Monitor is intended for non-invasive monitoring of single or twin fetuses during ante partum examination, labor and delivery. FHR often exhibits decelerations and accelerations in response to uterine contractions or fetal movements; certain patterns are indicative of hypoxia. Examination of these patterns, the baseline level, and variability characteristics can indicate the need to alter the course of labor with drugs or perform an operative delivery



**Individual activity 4.1**

Explain the purpose and clinical applications of the Fetal Monitor device.

**Time: 3mns**

### 4.2. WORKING PRINCIPLE

Fetal monitors detect FHR externally by using an ultrasound transducer to transmit and receive ultrasonic waves; the frequency (or Doppler) shift of the reflected signal is proportional to the velocity of the reflecting structure—in this case, the fetal heart. A transducer contains one or more piezoelectric elements that convert an electrical signal into ultrasonic energy that can be transmitted into tissues. When this ultrasonic energy is reflected back from the tissues, the transducer reconverts it to an electrical signal that can be used to create a waveform for display and recording and an audible FHR (sound created by the frequency shift of the ultrasonic signal).



**Learning activity 4.2**

Discuss the working principles of the Fetal Monitor device.

**Time: 3mns**

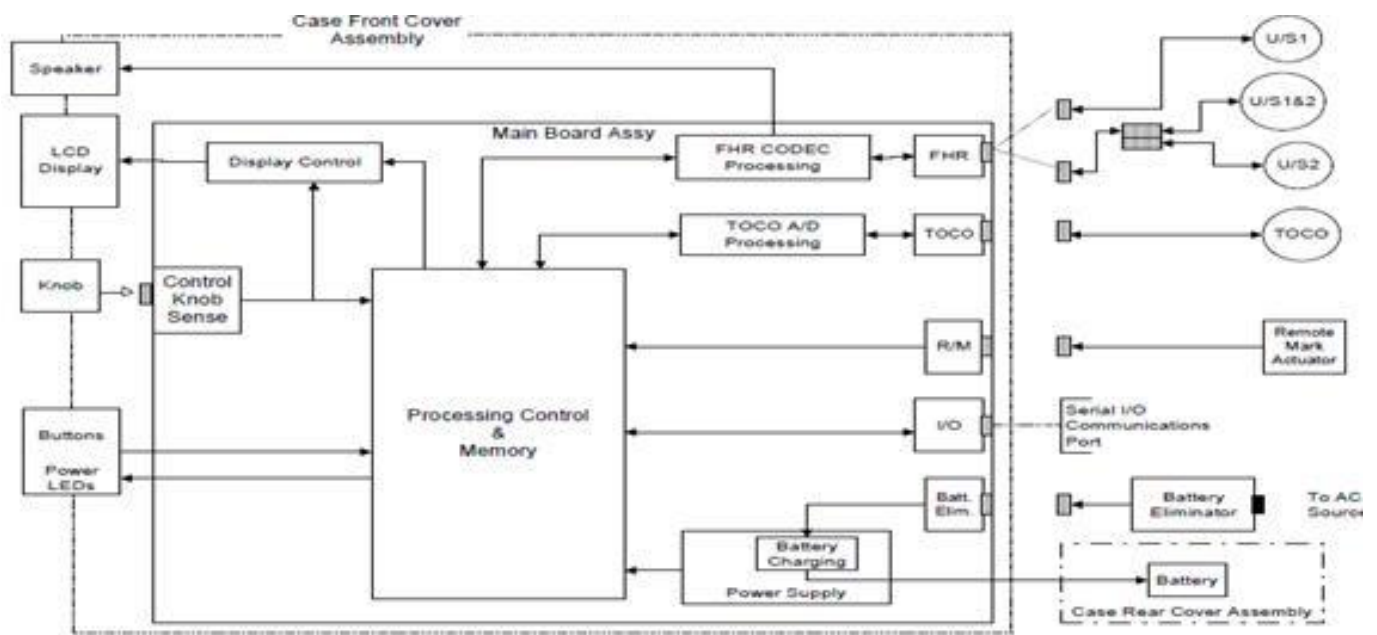

Figure 5.block diagram of fetal monitor

## 4.3. BASIC PARTS AND FUNCTION

### 4.3.1 BASIC PARTS

- Touch screen display
- Powers LED
- Paper drawer
- Paper drawer release
- Connectors
- ON/OFF switch
- Power connector
- Carrying handle
- Built-in stand
- Display release
- Fetal sensor sockets

### 4.3.2. BASIC PARTS FUNCTION

#### Touch screen display

- ✓ This unit of fetal monitor is to display the information of all parameters.

#### Powers LED

- ✓ This part of the fetal monitor is used to indicate power availability.

#### Paper drawer

- ✓ This part of the fetal monitor is door of printer

#### Paper drawer release

- ✓ Use for releasing printer door

#### Connectors

- ✓ This unit of fetal monitor is used for connecting the cables

#### ON/OFF switch

- ✓ This part of the fetal monitor is used to turn on/off the device.

#### Power connector

- ✓ For connecting the power cables

#### Carrying handle, Built-in stand and Display release

- ✓ To handle the machine , For standing purpose, and to release the display unit

#### Fetal sensor sockets

- ✓ This part of the fetal monitor is uses for sensor inlets



#### Learning activity 4.4.

Discuss the functions of the components of the Fetal Monitor device.

Time: 6mns

## 4.4. SAFETY AND CARE OF THE DEVICE

1. This device is not intended for use in intensive care units, operating rooms or for home use.
2. EXPLOSION HAZARD- Do not use this device in the presence of flammable anesthetic mixture with air, with oxygen or with nitrous oxide.
3. Shock Hazard–The power receptacle must be a three-wire grounded outlet. A hospital grade outlet is required. Never adapt the three-prong plug from the monitor to fit a two-slot outlet.
4. Do not apply this monitor and other ultrasonic equipment simultaneously on a same patient, due to the potential of leakage current superposition.
5. Do not apply this monitor simultaneously with other PATIENT-connected equipment, such as, a cardiac pacemaker or other electrical stimulators.
6. Do not use the monitor with RF surgical equipment.
7. Do not switch on device power until all cables have been properly connected and verified.
8. Do not touch the signal input or output connector and the patient simultaneously.
9. Equipment and devices that connect to the Monitor should form an equipotential body to ensure effective grounding.
10. Disconnect power cord before changing fuses. Replace the fuses with those of the same Specifications only.
11. SHOCK HAZARD- Do not attempt to connect or disconnect a power cord with wet hands. Make certain that your hands are clean and dry before touching a power cord.
11. SHOCK HAZARD- Do not remove the top panel cover during operation or while power is connected.



### Learning activity 4.5

List the appropriate safe handling of the Fetal Monitor device.

Time: 4mns

## 4.5. TROUBLESHOOTING TECHNIQUES

Generally troubleshooting is a problem solving techniques, often applied to repair a failed process of a system or a device.

### 4.5.1 RECEIVE MAINTENANCE REQUEST

- o Prepare
- o PPE(personal protective equipment )
- o Cleaning material
- o Melt meter to check electrical parameters
- o Mechanical and electrical tool kits to trouble shoot
- o User manual
- o Service manual
- o Checklists to check qualitative and quantitative data



## 4.5. 2 TROUBLESHOOTING PROCEDURES

### I) Physical Inspection

- o Observe if there is physical damage

### II) Power supply check up

- o check if there is a power from power out let , power supply cable and trace all power flowing path
- o Check the electrical status of Control panel.

### III) System verification

- ✓ Verify the system is on and information is displayed on LCD.

### IV) Volume control and transducer checking

- ✓ Checks the status of volume control and Check that the correct transducer is connected.

### V) Recorder checking

- ✓ Check that the recorder checking is turned on; paper is inserted into the recorder correctly.
- ✓ Check recorder door is correctly closed and paper moves out of the recorder at the correct rate.



#### Learning activity 4.5:

Make a group of 4/5 and perform troubleshooting activity/ steps of the Fetal Monitor device.

Time: 5mns

## 4.5 MAINTENANCE AND REPAIR

	Symptoms	Probable cause	Solutions
1	<b>No display information on LCD</b>	Not the system is switched on	Check/ Verify the system is on
		No power from power out let	Check the power out let and fix the problem
		Burnt cables	fix/ change it
		Burnet fuses	Replace the blown fuses
		power board failure	Repair/ change the power board
2	<b>If Keyboard does not respond</b>	Not the system is switched on	Verify the system is on and that the fuses are intact.
		The system busy/stacks	Reset system by turning off then back on.
	<b>No FHR information on display</b>	inappropriate transducer selection	select and connect correct transducer
3	<b>FH trace printed on recorder.</b>	Transducer failure/loose connection	Check for audio FH complex and reposition transducer until clearly heard.
4	<b>If there is No chart printed.</b>	Not the recorder turned on	Check that the recorder is turned on. .
		The paper is not inserted correctly	Check paper is inserted into the recorder correctly.
		The door is not closed appropriately	<ul style="list-style-type: none"> <li>✓ Check recorder door is correctly closed .</li> <li>✓Check that paper moves out of the recorder at the correct rate.</li> </ul>

5	<b>If there is No sound from loudspeaker</b>	The system is not turned on	Verify the system is on and that the fuses are intact.
		Low volume	Set volume control high.
		inappropriate transducer selection	Select the correct transducer.
		Loose transducer connection	connect the transducer appropriately



**Group activity 4.6:**  
 Make a group of 4/5 and perform maintenance activity of the failed part of the Fetal Monitor device.  
 Monitor device.  
**3:Mns**

**4.6. PREVENTIVE MAINTENANCE PROCEDURE**

- ✓ Clean the device and check the device and electrode.
- ✓ Maintain the device and the electrode clean by rubbing the device with an alcohol cloth at least once a month. Please do not use lacquer, thinner, ethylene, oxide.
- ✓ Keep the cable away from dirt or filth, cleanse it with a cloth soaked with warm water (40°C/104 F) and cleanse it with clinical alcohol once a week.
- ✓ Please do not soak the probe cable in liquid or cleanser and keep the device and cables from any types of liquid.



**Group activity 4.7:**  
 Make a group of 4/5 and perform preventive maintenance procedure of the Fetal Monitor device.  
**Time: 5mns**

**4.7 PERFORMANCE TEST FOR FETAL MONITOR**

Check point	Check content	Result	
		Yes	No
1. physical	All external components are statted properly		
2. chart printer	paper moves out of the recorder at the correct rate, door is correctly close and open		
3. electrical unit	Turn on the machine and check the machine is running		
4. FHR information on display	audio FH complex and position of transducer		
5. loudspeaker	Sound from loud speaker		



### Group activity 4.7

Make a group of 4/5 and perform performance test of the Feta Monitor device.

Time: 3mns

## 4.8.SUMMARY

- Fetal monitoring provides graphic and numeric information on fetal heart rate (FHR) and maternal uterine activity (UA).
- Fetal monitors detect FHR externally by using an ultrasound transducer to transmit and receive ultrasonic waves.

### Basic parts

- Touch screen display
- Powers LED
- Paper drawer
- Paper drawer release
- Connectors
- ON/OFF switch
- Power connector
- Carrying handle
- Built-in stand
- Display release

# Chapter 5:

## CPAP Machine

### CHAPTER DESCRIPTION:

This Chapter describes MCH medical devices designed to equip biomedical engineers/technicians to maintain MCH medical equipment's specifically CPAP Machine.

### COURSE GOAL:

At the end of this chapter the participant will be able to:

- Maintain CPAP machine based on the acquired knowledge, skill and attitude..

### SPECIFIC OBJECTIVES:

At the end of this chapter the participant will be able to:

- Describe purpose of CPAP machine
- Explain working principle of CPAP machine
- Differentiate basic parts and function of CPAP machine
- Perform troubleshooting of CPAP machine
- Perform preventive ,curative maintenance and performance test of CPAP machine
- Practice safe handling of CPAP machine

### CHAPTER OUTLINE

- 5.1. Purpose/Clinical application of CPAP machine
- 5.2. Working principle of CPAP machine
- 5.3. Basic parts and function of CPAP machine
- 5.4. Troubleshooting of CPAP machine
- 5.5. Preventive curative maintenance and performance test of CPAP machine
- 5.6. Safe handling of CPAP machine
- 5.7. Summary

### 5.1. PURPOSE / CLINICAL APPLICATION

Nasal CPAP therapy aims to support neonates, especially pre-term and low-birth weight newborns, who can breathe spontaneously but inadequately.



#### Learning activity 5.1:

Explain the purpose and clinical applications of the CPAP Machine.

Time: 3mns

### 5.2 WORKING PRINCIPLE

The CPAP has three major components the gas source, pressure generator and the patient interface. The pressure generator indicates the pressure of CPAP by observing the length of the tubing that is immersed in the water. The pressure is created in the bubble CPAP system, by placing distal expiratory tubing in the water tank of the system.

The gas source of the bubble system contains an oxygen blender, connected to a source of oxygen and compressed air. These two mixtures of compressed air and oxygen are used to supply an appropriate concentration of oxygen. The new blended oxygen is the circulated through corrugated tubing. The patient interface consists of nasal prongs, which are basically the nasal interface between the infant's airway and circuit. To prevent nasal traumas it is very important that the nasal interface is applied to the infant without air leakage while measurements are being taken. In concluding, it can be said that this particular device has a vital role to play in assisting young babies with breathing issues.



#### Learning activity 5.2

Explain the working principles of the CPAP Machine.

Time: 2mns

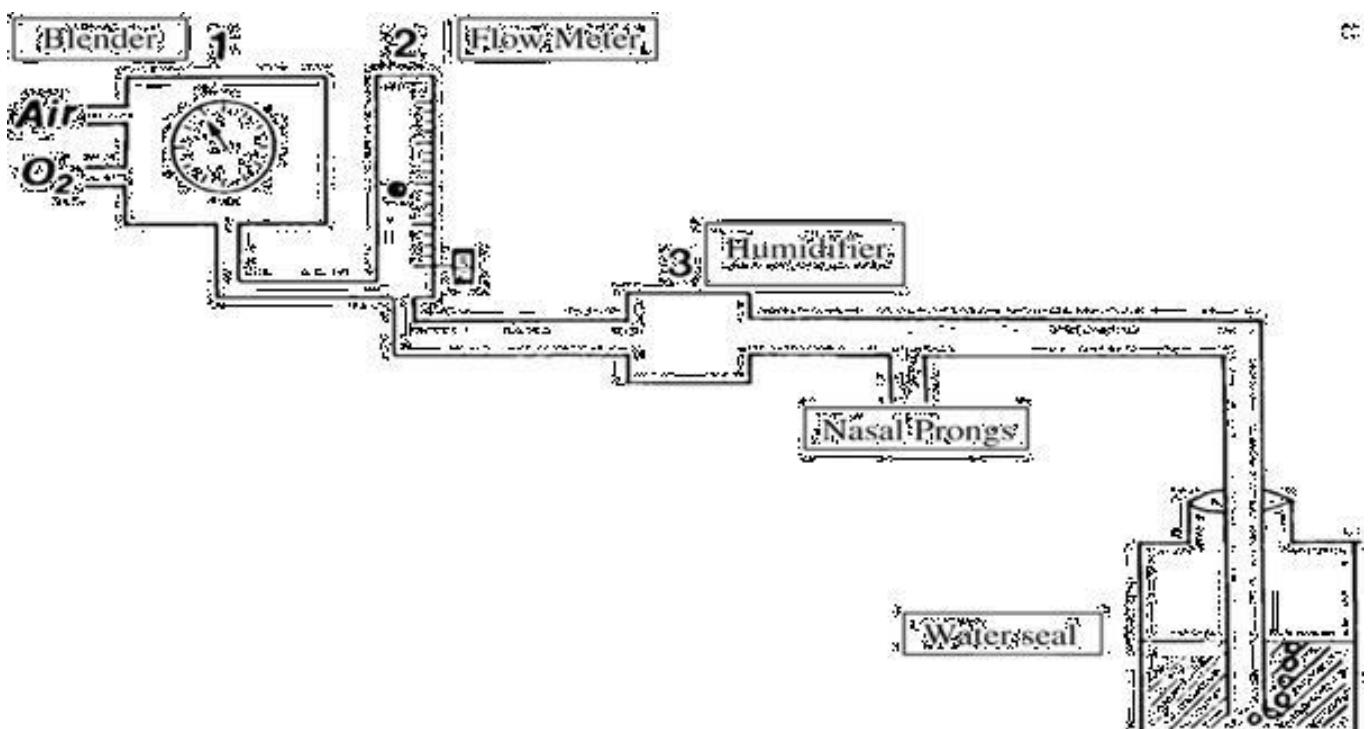

Figure 6. Block diagram for CPAP system

## 5.3 BASIC PARTS AND FUNCTION

### 5.3.1 BASIC PARTS

CPAP machine consists of three major components/Parts:

- Gas source
- Pressure generator
- Patient interface

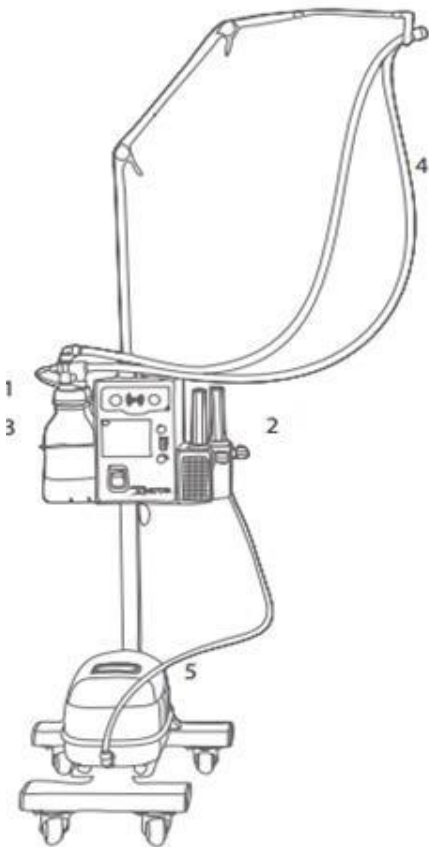

Figure 7. CPAP Machine components

#### 1. PEEP/CPAP

#### 2. Gas Mixing

- Highly visible oxygen and air rotameters to set gas flow rates
- FiO<sub>2</sub> for quick oxygen percentage calculation

#### 3. Humidifier

- User adjustable heater power for different operating environments
- Humidifies gas stream to prevent drying of the airways

#### 4. Patient Circuit

- reusable silicone breathing circuit
- pinch proof and kink resistant
- chemically disinfectable
- internal heater wire and temperature sensors included
- digital temperature sensor for accurate temperature control
- full PID temperature controller with advanced safety features

#### 5. Air Compressor

- integrated air compressor to avoid need for an external air source
- combined power switch to turn CPAP and compressor on and off with one switch
- diaphragm type for clean, long lasting air supply



#### Learning activity 5.3

Explain the main parts and function of CPAP Machine.

Time: 3mns

### 5.3.2 PARTS FUNCTION

#### 1. Gas source:

✓ An oxygen blender connected to a source of oxygen and compressed air is used to supply an appropriate concentration of inspired oxygen. The humidified blended oxygen is then circulated through corrugated tubing.

## 2. Pressure generator:

✓ Pressure in the bubble CPAP system is created by placing the distal expiratory tubing in water. Designated pressure is determined by the length of tubing immersed.

## 3. Patient interface:

✓ Nasal prongs are used as the nasal interface between the circuit and the infant's airway. Short and wide nasal prongs allow for a low resistance to air flow. It is important that the nasal interface be applied to the infant without air leakage while taking measures to prevent nasal trauma.

### 5.3.3. CLASSIFICATION

1. Complete advanced nasal CPAP system

2. Bubble CPAP system

➤ Complete advanced bubble CPAP system, it is composed of the following components

1. Monitoring Gas Mixer (the flow driver)

2. Control panel and adjustment display

3. Patient interface (nasal prong or a nasal mask)

4. Circuit security pressure relief valve

5. Active humidifier and accessories

6. Pressure regulating valve

7. Nasal tubes

8. Gas hoses and connectors



#### Learning activity 5.4

List the types/classification and explain each of the CPAP Machine.

Time: 2mns

### 5.3.4 SAFETY AND CARE OF THE DEVICE

o Do not use the humidifier in the presence of inflammable anesthetic gases because there is the explosion risk

o Always regulate the gas flow before applying the system to the patient o

Make sure the humidifier water reservoir is on the correct water level.



#### Learning activity 5.5

Discuss the safety of the CPAP Machine.

Time:3mns



## 5.4. TROUBLESHOOTING PROCEDURE

### 5.4.1. RECEIVE MAINTENANCE REQUEST

- o Prepare
- o PPE(personal protective equipment )
- o Cleaning material
- o Melt meter to check electrical parameters
- o Mechanical and electrical tool kits to trouble shoot
- o Service manual
- o Checklists to check qualitative and quantitative data

### 5.4.2 PHYSICAL INSPECTION

- i. Physically observe (Smell for burning cables and components, Hear for abnormal noise, Look physical breakage, if any)
- ii. Check if there is a power from power out let , power supply cable and trace all power flowing path
- iii. Check the entire circuit from wall to baby to outlet to ensure that it is functioning correctly.
- iv. Check for leaks and/or broken connections.
- v. Check the status of
  - Air temperature control
  - Integral humidification
  - Alarm system
- vi. Check the status of temperature sensor, oxygen sensor, humidifier sensor display unit and the connection with patient probe
- vii. check for Blended air/oxygen gas supply
- viii. check whether the Flow is between 5-10 liters/min
- ix. check whether the Humidifier temperature is correct (36.8-37.3 °C)
- x. check whether the Humidifier water level is correct
- xi. check whether the Oxygen analyzer correctly set
- xii. Corrugated tubing correctly placed
- xiii. Once the system is applied, check that the prongs are positioned appropriately and that the CPAP system is bubbling at 5 cm H<sub>2</sub>O.
- xiv. Check the CPAP delivery system for proper functioning and the system bubbling properly

### 5.4.3. POWER SUPPLY CHECK UP

- i. Check if there is a power from power out let , power supply cable and trace all power flowing path
- ii. Check the electrical status of Control panel.

### 5. 4.4. SYSTEM VERIFICATION

- ✓ Verify the system is on and information is displayed on LCD.

### 5.4.5 VOLUME CONTROL AND TRANSDUCER CHECKING

✓ Checks the status of volume control and Check that the correct transducer is connected.



**Learning activity 5.4:**

Discuss the activity/ steps troubleshooting of the CPAP Machine.

**Time: 3mns**

### 5.5.5 MAINTENANCE AND REPAIR

	Symptom	Possible cause	Solution
1	CPAP does not turn on.	i. Not plugged in	1. Check to see that the CPAP is plugged in and that the outlet is switched on.
		ii. Power switch is not in the on position	2. Check to see if the power switch is in the “on” position
2	The machine is not bubbling	1. circuit problem and/or	1. Systematically check and tight the circuit
		2. prongs problem from the nose	2. occlude the prongs with your fingers
3	Humidifier is connected to an AC source, but doesn't turn on	Lack of energy on the out let AC	Try to connect known AC source
4	Sound alarm in the CPAP module	Gas entry line with unbalanced pressure	1. verify the air/o2 entry pressures in the CPAP must be equalized in 3,5 kgf/cm2 2. verify difference in the entry pressures, they must be lower than 1,4kgf/cm2
5	Signal of water low level on the humidifier	Little water in the humidifier water	Fulfill the humidifier jar with water
		Poor contact between humidifier pitcher and the base	Clean and/or dry the lodging of the humidifier pitcher
6	power supply cable failure		Change another power cable
7	There is no air/O2 flow.		<ul style="list-style-type: none"> <li>• Check air/o2 sources tubing connections.</li> <li>• Make sure the air/o2 sources is on and the nozzle is completely attached.</li> </ul>
8	Water does not bubble when the prongs are placed in the airway		<ul style="list-style-type: none"> <li>i. The prongs may be too small - replace with a larger size.</li> <li>ii. Reposition the prongs.</li> <li>iii. Air may be leaking out of the mouth; gently close the baby's mouth for a few moments to encourage nose breathing.</li> </ul>

9	<b>The airflow is weak and cannot reach 10 L/min</b>	connections and tubing for leaks	Check connections and tubing for leaks. • If connections are loose, tighten them. If leaks are found, fix them.
10	<b>temperature sensor is not working</b>	failure in temperature sensor	fix/change temperature sensor
11	<b>Water level sensor is not working</b>	failure in Water level sensor	fix/change Water level sensor
12	<b>oxygen sensor is not working</b>	failure in oxygen sensor	fix/change oxygen sensor

### 5.5 PREVENTIVE MAINTENANCE PROCEDURE

- o Clean the exterior and interior parts
- o Proceed the cleaning of the water level sensor point every 24 hrs.
- o Cleaning water level sensor
- o Evaluation of air/O2 system
- o Checking O2 system
- o Calibrate after each maintenance



**Group activity 5.5**

Make a group of 4/5 and perform the main preventive Maintenance of the CPAP Machine.

**Time:2mns**

#### 5.5.1. PERFORMANCE TEST FOR CPAP MACHINE

Check point	Check content	Result	
		Yes	No
4.1 physical	All external components are stteded properly		
4.2 Nasal prongs	Nasal prongs size is correct and positioned correctly		
4.3 electrical unit	Turn on the machine and check the machine is running		
4.4 sensors	temperature sensor, water level (humidifier) sensor, oxygen sensor are working properly		
4.5 oxygen and temperature level	Oxygen and temperature concentration are accurate		
4.6 air/O2 blender	The blender is set at the appropriate Percentage of inspired oxygen.		
4.7 humidifier	The humidifier holds the correct Amount of water.		
4.8 temperature	The inspired gas temperature is Appropriate.		
4.9 outlet bottle	The outlet bottle is bubbling.		
5.0 oxygen analyzer	The oxygen analyzer reads the same as the blender setting		

5.1 tubing in the outlet bottle	The tubing in the outlet bottle is fixed at 5 cm of water		
5.2 flow meter	The flow meter is set between 5 and 10 liters/minute.		
5.3 corrugated tubing	The corrugated tubing does not contain water and correctly placed.		



**Learning activity 5.9**

Make a group of 4/5 and perform performance test of the CPAP Machine.

**Time: 2mns**

**5.7. SUMMARY**

➤ The CPAP has three major components the gas source, pressure generator and the patient interface.

**CPAP machine consists of three major components/Parts:**

- Gas source
- Pressure generator
- Patient interface

**Classification**

- 9. Complete advanced nasal CPAP system
- 10. Bubble CPAP system

Annex 2. Trainee Evaluation Check List for Infant Incubator		
<b>Course Title:</b>	<b>Infant Incubator</b>	
<b>Learning Objective:</b>	To develop the capacity of Biomedical Engineers/Technicians to maintain Infant Incubator based on the acquired knowledge, skill and attitude.	
<b>Date of assessment:</b>		
<b>Venue of assessment:</b>		
<b>During the demonstration of knowledge, skills and attitude, the learner has:</b>	<b>Yes</b>	<b>No</b>
1. Demonstrated the correct handling of Infant Incubator		
2. Identified all parts of Infant Incubator		
3. Prepared the required hand tools, Instruments and materials		
4 .performed preventive maintenance procedure		
<ul style="list-style-type: none"> <li>✓ Cleaning Fan, Filters/ Replace</li> <li>✓ Safety test &amp; all other functional check</li> <li>✓ Heater coil resistance &amp; its contacts</li> <li>✓ Casters &amp; Wheels Consumables- Iris Port covers, sensors, Air Filters</li> </ul>		
B.Oxygen and temperature concentration are accurate check & calibrate Sensors.		
C. Bearings of Motor (Fan)		
5.performed corrective maintenance procedure:		
5.1 Gathering information about the failure		
5.2 Physical observation		
5.3 power supply system check up		
5.4 Alarm sounding and manual indicator flashing check up		
5.5 check the status of all sensors		
5.6 check the status of heating element		
6. safety rules Followed in performing the activities		
<b>The trainee's demonstration and performance was:</b>	<b>Satisfactory</b>	<b>Not Satisfactory</b>
Trainee's Name	signature:	Date:
Trainer's Name	signature:	Date:

**Annex 3. Trainee Evaluation Check List for Infant Radiant Warmer**

<b>Course Title:</b>	<b>Infant radiant warmer</b>	
<b>Learning Objective:</b>	To develop the capacity of Biomedical Engineers/Technicians to maintain Infant radiant warmer based on the acquired knowledge, skill and attitude.	
<b>Date of assessment:</b>		
<b>Venue of assessment:</b>		
<b>During the demonstration of knowledge, skills and attitude, the learner has:</b>	<b>Yes</b>	<b>No</b>
1. Demonstrated the correct handling of Infant radiant warmer		
2. Identified all parts of Infant radiant warmer		
3. Prepared the required hand tools, Instruments and materials		
4 .performed preventive maintenance procedure		
a. Clean the main frame with a mild detergent solution.		
b. The mattress, x-ray grid and side panels cleaned without immersing by using a suitable disinfectant agent.		
C. Clean the skin temperature probe by gently wiping with a soft, damp cloth containing detergent or disinfecting solution		
5.performed corrective maintenance procedure:		
5.1 Gathering information about the failure		
5.2 Physical observation		
5.3 power supply system check up		
5.4 Alarm sounding and manual indicator flashing check up		
5.5 check the status of all sensors		
5.6 check the status of heating element		
6. safety rules Followed in performing the activities		
<b>The trainee’s demonstration and performance was:</b>	<b>Satisfactory</b>	<b>Not Satisfactory</b>
Trainee’s Name	signature:	Date:
Trainer’s Name	signature:	Date:

## Annex 4. Trainee Evaluation Check list for fetal Monitor

<b>Course Title:</b>	<b>CPAP Machine</b>	
<b>Learning Objective:</b>	To develop the capacity of Biomedical Engineers/Technicians to maintain Infant Incubator based on the acquired knowledge, skill and attitude.	
<b>Date of assessment:</b>		
<b>Venue of assessment:</b>		
<b>During the demonstration of knowledge, skills and attitude, the learner has:</b>	<b>Yes</b>	<b>No</b>
1. Demonstrated the correct handling of CPAP machine		
2. Identified all parts of CPAP machine		
3. Prepared the required hand tools, Instruments and materials		
4 performed preventive maintenance procedure		
a. Clean the main frame with a mild detergent solution.		
b. The humidifier, outlet bottle cleaned without immersing by using a suitable disinfectant agent.		
c. Clean the skin temperature probe by gently wiping with a soft, damp cloth containing detergent or disinfecting solution		
5. performed corrective maintenance procedure:		
5.1 Gathering information about the failure		
5.2 Physical observation		
5.3 power supply system check up		
5.4 Alarm sounding and manual indicator flashing check up		
5.5 check the status of all sensors		
5.6 check the status of heating element		
6. safety rules Followed in performing the activities		
<b>The trainee's demonstration and performance was:</b>	<b>Satisfactory</b>	<b>Not Satisfactory</b>
Trainee's Name	signature:	Date:
Trainer's Name	signature:	Date:



Annex 5. Trainee Evaluation Check list for CPAP Machine		
<b>Course Title:</b>	<b>Fetal Monitor Machine</b>	
<b>Learning Objective:</b>	To develop the capacity of Biomedical Engineers/ Technicians to maintain Fetal Monitor Machine based on the acquired knowledge, skill and attitude.	
<b>Date of assessment:</b>		
<b>Venue of assessment:</b>		
<b>During the demonstration of knowledge, skills and attitude, the learner has:</b>	<b>Yes</b>	<b>No</b>
1. Demonstrated the correct handling of Fetal Monitor Machine		
2. Identified all parts of Fetal Monitor Machine		
3. Prepared the required hand tools, Instruments and materials		
4 .performed preventive maintenance procedure		
a. Clean the main frame with a mild detergent solution.		
b. The LCD displays cleaned without immersing by using a suitable disinfectant agent.		
c. Cleaned the transducers probe by gently wiping with a soft, damp cloth containing detergent or disinfecting solution		
5. performed corrective maintenance procedure:		
5.1 Gathering information about the failure		
5.2 Physical observation		
5.3 power supply system check up		
5.4 Alarm sounding and manual indicator flashing check up		
5.5 check the status of all sensors		
5.6 check the status of heating element		
6. safety rules Followed in performing the activities		
<b>The trainee’s demonstration and performance was:</b>	<b>Satisfactory</b>	<b>Not Satisfactory</b>
Trainee’s Name	signature:	Date:
Trainer’s Name	signature:	Date:

# References

---

1. SRM University, unit 1incubater, radiant warmer, phototherapy unit. Pdf
2. The Republic of Uganda, MINISTRY OF HEALTH, Training guide for National and Regional User Trainers volume 1, uga\_04.pdf
3. The Republic of Uganda, MINISTRY OF HEALTH, Training guide for National and Regional User Trainers volume 2, uga\_05.pdf
4. warming\_unit\_radiant\_infant.pdf
5. ONTOP-IN 2012: Radiant Warmer job aids.pdf
6. Medical Equipment maintenance manual, Ministry of Health and Family Welfare, New Delhi, October 2010
7. FETAL MONITOR GIMA FC1400 Operation Manual, 688.pdf
8. sonic aid Fetal Monitoring,20110615151756.pdf
9. EDANUSA F9 Manual, service manual.pdf
10. Philips Avalon Fetal Monitor FM20 / FM30 / FM40 / FM50 User Manual.pdf
11. XT Auto CPAP System Instruction Manual.pdf
12. Schematic-diagram-of-bubble-CPAP-circuit <https://www.researchgate.net/figure/10772354>
13. Bubble nasal CPAP manual Riyadh AL-Kharj Hospital Program Neonatal intensive care, 2005



